

HARDWARE INSTALLATION GUIDE

PRODUCT MODEL : **DGS-1210/ME SERIES**
METRO ETHERNET SWITCHES
RELEASE 2.10

Information in this document is subject to change without notice.

© 2016 D-Link Computer Corporation. All rights reserved.

Reproduction in any manner whatsoever without the written permission of D-Link Computer Corporation is strictly forbidden.

Trademarks used in this text: D-Link and the D-Link logo are trademarks of D-Link Computer Corporation; Microsoft and Windows are registered trademarks of Microsoft Corporation.

Other trademarks and trade names may be used in this document to refer to either the entities claiming the marks and names or their products. D-Link Computer Corporation disclaims any proprietary interest in trademarks and trade names other than its own.

FCC Warning

This equipment has been tested and found to comply with the limits for a Class A digital device, pursuant to Part 15 of the FCC Rules. These limits are designed to provide reasonable protection against harmful interference when the equipment is operated in a commercial environment. This equipment generates, uses, and can radiate radio frequency energy and, if not installed and used in accordance with this user's guide, may cause harmful interference to radio communications. Operation of this equipment in a residential area is likely to cause harmful interference in which case the user will be required to correct the interference at his own expense.

CE EMI CLASS A WARNING

This equipment is compliant with Class A of CISPR 32. In a residential environment this equipment may cause radio interference.

Table of Contents

Table of Contents	i
Intended Readers	1
Typographical Conventions	1
Notes and Cautions.....	1
Safety Instructions.....	1
Safety Cautions	1
General Precautions for Rack-Mountable	2
Protecting Against Electrostatic Discharge	3
1 Product Introduction	4
Switch Description.....	4
Front Panel Description.....	4
LED Indicators.....	8
Rear Panel Description	10
Side Panel Description.....	12
Gigabit Fiber Ports	12
Connecting the DPS-200A/500A/500DC to the RPS Port (for DGS-1210-10/12TS/20/28/28X/28XS/52/ME only).....	13
Installing the RPS into a Rack-mount Chassis (for DGS-1210-10/12TS/20/28/28X/28XS/52/ME only)	14
DPS-800 Rack-mount Chassis.....	14
2 Installation	15
Step 1: Package Contents	15
Step 2: Installation Guidelines	15
Desktop or Shelf Installation.....	15
Rack Installation	15
Step 3 – Plugging in the AC Power Cord.....	16
Power Failure	17
3 Switch Management	18
Management Options.....	18
Using Web-based Management	18
Supported Web Browsers	18
Connecting to the Switch.....	18
Login Web-based Management	19
Connecting the Console Port.....	19
To connect a terminal to the console port	19
Password Protection.....	20
Assigning IP Addresses	21
SNMP Settings	22
Traps	23
Management Information Base (MIB)	23
4 Web-based Switch Configuration	24
Logging onto the Web Manager.....	24
Web-based User Interface	24
Areas of the User Interface	24
Web Pages.....	25
Appendix A – Ethernet Technology	27
Appendix B – Cables and Connectors	34
Appendix C – Module Specs and Cable Lengths	36

Intended Readers

The **DGS-1210/ME Series Hardware Installation Guide** contains information for set up and management of the Switch. This manual is intended for network managers familiar with network management concepts and terminology. For all practical reasons all the switches in this series will be simply referred to as the Switch throughout this manual. All example screenshots are taken from the **DGS-1210-28/ME** Switch.

Typographical Conventions

Convention	Description
[]	In a command line, square brackets indicate an optional entry. For example: [copy filename] means that optionally you can type copy followed by the name of the file. Do not type the brackets.
Bold font	Indicates a button, a toolbar icon, menu, or menu item. For example: Open the File menu and choose Cancel . Used for emphasis. May also indicate system messages or prompts appearing on screen. For example: You have mail . Bold font is also used to represent filenames, program names and commands. For example: use the copy command .
Boldface Typewriter Font	Indicates commands and responses to prompts that must be typed exactly as printed in the manual.
Initial Capital Letter	Indicates a window name. Names of keys on the keyboard have initial capitals. For example: Click Enter.
Italics	Indicates a window name or a field. Also can indicate a variables or parameter that is replaced with an appropriate word or string. For example: type <i>filename</i> means that the actual filename should be typed instead of the word shown in italic.
Menu Name > Menu Option	Menu Name > Menu Option Indicates the menu structure. Device > Port > Port Properties means the Port Properties menu option under the Port menu option that is located under the Device menu.

Notes and Cautions

In this guide, the term “Switch” (first letter capitalized) refers to DGS-1210/ME Metro Ethernet Switch, and “switch” (first letter lower case) refers to other Ethernet switches. Some technologies refer to terms “switch”, “bridge” and “switching hubs” interchangeably, and both are commonly accepted for Ethernet switches.



A **NOTE** indicates important information that helps make better use of the device.



A **CAUTION** indicates potential property damage or personal injury.

Safety Instructions

Use the following safety guidelines to ensure your own personal safety and to help protect your system from potential damage. Throughout this safety section, the caution icon () is used to indicate cautions and precautions that need to be reviewed and followed.

Safety Cautions

To reduce the risk of bodily injury, electrical shock, fire, and damage to the equipment observe the following precautions:

- Observe and follow service markings.
 - Do not service any product except as explained in the system documentation.
 - Opening or removing covers that are marked with the triangular symbol with a lightning

- bolt may expose the user to electrical shock.
- Only a trained service technician should service components inside these compartments.
- If any of the following conditions occur, unplug the product from the electrical outlet and replace the part or contact your trained service provider:
 - Damage to the power cable, extension cable, or plug.
 - An object has fallen into the product.
 - The product has been exposed to water.
 - The product has been dropped or damaged.
 - The product does not operate correctly when the operating instructions are correctly followed.
- Keep your system away from radiators and heat sources. Also, do not block cooling vents.
- Do not spill food or liquids on system components, and never operate the product in a wet environment. If the system gets wet, see the appropriate section in the troubleshooting guide or contact your trained service provider.
- Do not push any objects into the openings of the system. Doing so can cause fire or electric shock by shorting out interior components.
- Use the product only with approved equipment.
- Allow the product to cool before removing covers or touching internal components.
- Operate the product only from the type of external power source indicated on the electrical ratings label. If unsure of the type of power source required, consult your service provider or local power company.
- To help avoid damaging the system, be sure the voltage selection switch (if provided) on the power supply is set to match the power available at the Switch's location:
 - 115 volts (V)/60 hertz (Hz) in most of North and South America and some Far Eastern countries such as South Korea and Taiwan
 - 100 V/50 Hz in eastern Japan and 100 V/60 Hz in western Japan
 - 230 V/50 Hz in most of Europe, the Middle East, and the Far East
- Also, be sure that attached devices are electrically rated to operate with the power available in your location.
- Use only approved power cable(s). If you have not been provided with a power cable for your system or for any AC-powered option intended for your system, purchase a power cable that is approved for use in your country. The power cable must be rated for the product and for the voltage and current marked on the product's electrical ratings label. The voltage and current rating of the cable should be greater than the ratings marked on the product.
- To help prevent electric shock, plug the system and peripheral power cables into properly grounded electrical outlets. These cables are equipped with three-prong plugs to help ensure proper grounding. Do not use adapter plugs or remove the grounding prong from a cable. If using an extension cable is necessary, use a 3-wire cable with properly grounded plugs.
- Observe extension cable and power strip ratings. Make sure that the total ampere rating of all products plugged into the extension cable or power strip does not exceed 80 percent of the ampere ratings limit for the extension cable or power strip.
- To help protect the system from sudden, transient increases and decreases in electrical power, use a surge suppressor, line conditioner, or uninterruptible power supply (UPS).
- Position system cables and power cables carefully; route cables so that they cannot be stepped on or tripped over. Be sure that nothing rests on any cables.
- Do not modify power cables or plugs. Consult a licensed electrician or your power company for site modifications. Always follow your local/national wiring rules.
- When connecting or disconnecting power to hot-pluggable power supplies, if offered with your system, observe the following guidelines:
 - Install the power supply before connecting the power cable to the power supply.
 - Unplug the power cable before removing the power supply.
 - If the system has multiple sources of power, disconnect power from the system by unplugging all power cables from the power supplies.
- Move products with care; ensure that all casters and/or stabilizers are firmly connected to the system. Avoid sudden stops and uneven surfaces.

General Precautions for Rack-Mountable

Observe the following precautions for rack stability and safety. Also, refer to the rack installation documentation.

- Systems are considered to be components in a rack. Thus, "component" refers to any system as

well as to various peripherals or supporting hardware.

	<p>CAUTION: Installing systems in a rack without the front and side stabilizers installed could cause the rack to tip over, potentially resulting in bodily injury under certain circumstances. Therefore, always install the stabilizers before installing components in the rack. After installing system/components in a rack, never pull more than one component out of the rack on its slide assemblies at one time. The weight of more than one extended component could cause the rack to tip over and may result in serious injury.</p>
---	--

- Before working on the rack, make sure that the stabilizers are secured to the rack, extended to the floor, and that the full weight of the rack rests on the floor. Install front and side stabilizers on a single rack or front stabilizers for joined multiple racks before working on the rack.
- Always load the rack from the bottom up, and load the heaviest item in the rack first.
- Make sure that the rack is level and stable before extending a component from the rack.
- Use caution when pressing the component rail release latches and sliding a component into or out of a rack; the slide rails can pinch your fingers.
- After a component is inserted into the rack, carefully extend the rail into a locking position, and then slide the component into the rack.
- Do not overload the AC supply branch circuit that provides power to the rack. The total rack load should not exceed 80 percent of the branch circuit rating.
- Ensure that proper airflow is provided to components in the rack.
- Do not step on or stand on any component when servicing other components in a rack.

	<p>NOTE: A qualified electrician must perform all connections to DC power and to safety grounds. All electrical wiring must comply with applicable local or national codes and practices.</p>
--	--

	<p>CAUTION: The system chassis must be positively grounded to the rack cabinet frame. Do not attempt to connect power to the system until grounding cables are connected. Completed power and safety ground wiring must be inspected by a qualified electrical inspector. An energy hazard will exist if the safety ground cable is omitted or disconnected.</p>
---	---

Protecting Against Electrostatic Discharge

Static electricity can harm delicate components inside the system. To prevent static damage, discharge static electricity from your body before touching any of the electronic components, such as the microprocessor. This can be done by periodically touching an unpainted metal surface on the chassis.

The following steps can also be taken prevent damage from electrostatic discharge (ESD):

1. When unpacking a static-sensitive component from its shipping carton, do not remove the component from the antistatic packing material until ready to install the component in the system. Just before unwrapping the antistatic packaging, be sure to discharge static electricity from your body.
2. When transporting a sensitive component, first place it in an antistatic container or packaging.
3. Handle all sensitive components in a static-safe area. If possible, use antistatic floor pads, workbench pads and an antistatic grounding strap.

1 Product Introduction

- **Switch Description**
- **Front Panel Description**
- **LED Indicators**
- **Rear Panel Description**
- **Side Panel Description**
- **Gigabit Fiber Port**
- **Connecting the DPS-200A/500A/500DC to the RPS Port
(for DGS-1210-10/12TS/20/28/28X/28XS/52/ME only)**
- **Installing the RPS into a Rack-mount Chassis (for DGS-1210-10/12TS/20/28/28X/28XS/52/ME only)**

Switch Description

The DGS-1210/ME Metro Ethernet Switch is equipped with Copper ports (10/100/1000Mbps), SFP ports (1000Mbps) and SFP+ ports (10G) that can be used to attach various networking devices to the network like Computers, Notebooks, Print Servers, Network Attached Storage devices, IP Cameras, VoIP PBX devices, and other Switches. The Small Form Factor Portable (SFP) ports can be used together with fiber-optical transceivers in order to connect various other networking devices, using a fiber-optic connection, to the network at Gigabit Ethernet speeds over great distances.

This DGS-1210/ME Metro Ethernet Switch provides unsurpassed performance, fault tolerance, scalability, robust security, standard-based interoperability and impressive technology to future-proof departmental and enterprise network deployments.

It allows IGMP Snooping and Authentication, QoS, Bandwidth Control, ACL and many security functions. It can be managed by Web UI, or commands via Telnet.

The DGS-1210/ME Metro Ethernet Switches have different port configuration (10/100/1000Base-T or SFP ports) that may be used in to uplink various network devices to the Switch, including PCs, hubs and other switches to provide a gigabit Ethernet uplink in full-duplex mode. The SFP (Small Form Factor Portable) ports are used with fiber-optical transceiver cabling in order to uplink various other networking devices for a gigabit link that may span great distances.

Front Panel Description

The front panel of the **DGS-1210-10/ME** switch consists out of the following:

- 8 10/100/1000Mbps Copper Ports
- 2 1000Mbps SFP port
- One RJ-45 Console Port
- LEDs for Power, Console, RPS, Link/Act for port 1 ~ 10

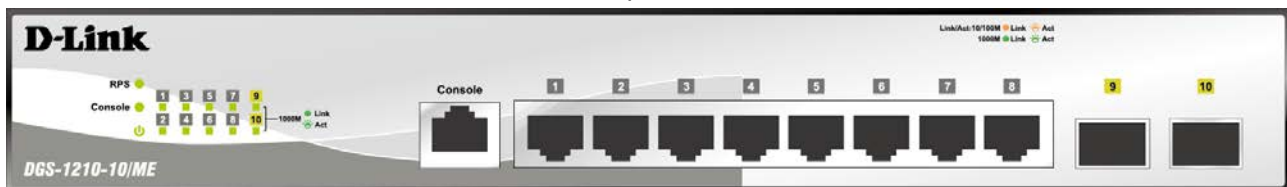

Figure 1.1 – DGS-1210-10/ME Front Panel



CAUTION: The MiniGBIC ports should use UL listed Optical Transceiver product, Rated Laser Class I. 3.3Vdc.

The front panel of the **DGS-1210-10P/ME** switch consists out of the following:

- 8 10/100/1000Mbps Copper Ports
- 2 1000Mbps SFP ports
- One RJ-45 Console Port

- LEDs for Power, PoE Max, Console, Link/Act for port 1 ~ 10
- Mode: By pressing the Mode button, the Port LED will switch between Link/Act and PoE modes.

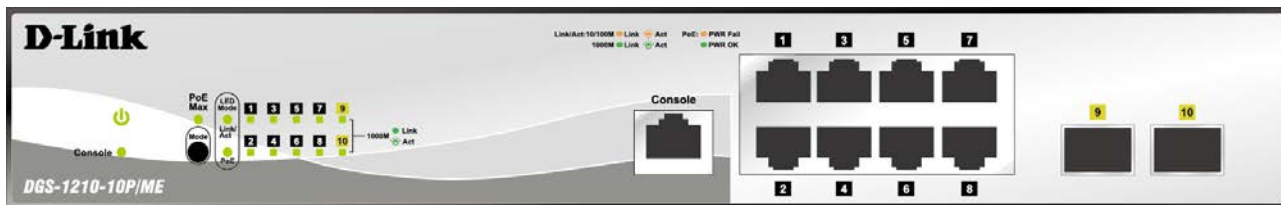

Figure 1.2 – DGS-1210-10P/ME Front Panel



CAUTION: The MiniGBIC ports should use UL listed Optical Transceiver product, Rated Laser Class I. 3.3Vdc.



NOTE: The power budget is 78 Watts for DGS-1210-10P/ME.

The front panel of the **DGS-1210-12TS/ME** switch consists out of the following:

- 10 1000Mbps SFP port
- 2 10/100/1000Mbps Copper Ports
- One RJ-45 Console Port
- LEDs for Power, Console, RPS, Link/Act for port 1 ~ 12



Figure 1.3 – DGS-1210-12TS/ME Front Panel



CAUTION: The MiniGBIC ports should use UL listed Optical Transceiver product, Rated Laser Class I. 3.3Vdc.

The front panel of the **DGS-1210-20/ME** switch consists out of the following:

- 16 10/100/1000Mbps Copper Ports
- 4 1000Mbps SFP port
- One RJ-45 Console Port
- LEDs for Power, Console, RPS, Link/Act for port 1 ~ 20

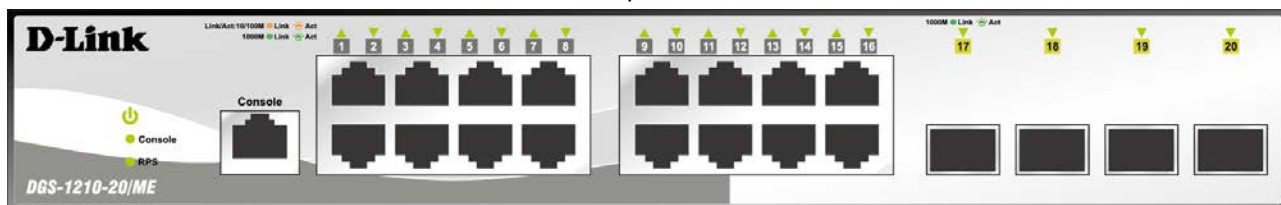

Figure 1.4 – DGS-1210-20/ME Front Panel



CAUTION: The MiniGBIC ports should use UL listed Optical Transceiver product, Rated Laser Class I. 3.3Vdc.

The front panel of the **DGS-1210-28/ME** switch consists out of the following:

- 24 10/100/1000Mbps Copper Ports
- 4 1000Mbps SFP port

- One RJ-45 Console Port
- LEDs for Power, RPS, Console, Link/Act for port 1 ~ 28



Figure 1.5 – DGS-1210-28/ME Front Panel



CAUTION: The MiniGBIC ports should use UL listed Optical Transceiver product, Rated Laser Class I. 3.3Vdc.

The front panel of the **DGS-1210-28P/ME** switch consists out of the following:

- 24 10/100/1000Mbps Copper Ports
- 4 1000Mbps SFP port
- One RJ-45 Console Port
- LEDs for Power, Console, Fan Error, Pwr Max, Link/Act for port 1 ~ 28
- Mode: By pressing the Mode button, the Port LED will switch between Link/Act and PoE modes

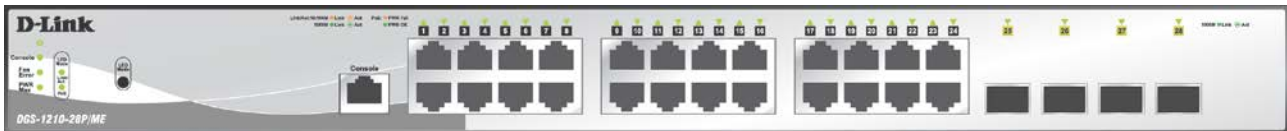

Figure 1.6 – DGS-1210-28P/ME Front Panel



CAUTION: The MiniGBIC ports should use UL listed Optical Transceiver product, Rated Laser Class I. 3.3Vdc.



NOTE: The power budget is 193 Watts for DGS-1210-28P/ME.

The front panel of the **DGS-1210-28MP/ME** switch consists out of the following:

- 24 10/100/1000Mbps Copper and PoE Ports
- 4 1000Mbps SFP port
- One RJ-45 Console Port
- LEDs for Power, Console, Fan Error, Pwr Max, Link/Act for port 1 ~ 28
- Mode: By pressing the Mode button, the Port LED will switch between Link/Act and PoE modes

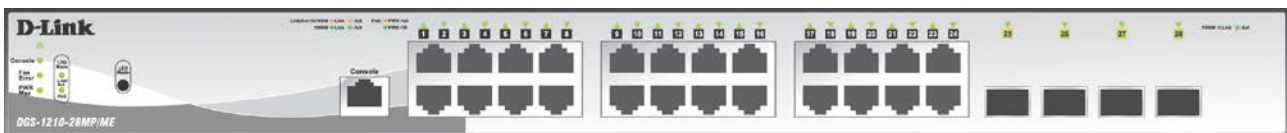

Figure 1.7 – DGS-1210-28MP/ME Front Panel



CAUTION: The MiniGBIC ports should use UL listed Optical Transceiver product, Rated Laser Class I. 3.3Vdc.



NOTE: The power budget is 370 Watts for DGS-1210-28MP/ME.

The front panel of the **DGS-1210-28X/ME** switch consists out of the following:

- 24 10/100/1000Mbps Copper Ports
- 4 1000Mbps SFP/10G SFP+ port
- One RJ-45 Console Port

- LEDs for RPS, Power, Console, Fan Error, Link/Act for port 1 ~ 28

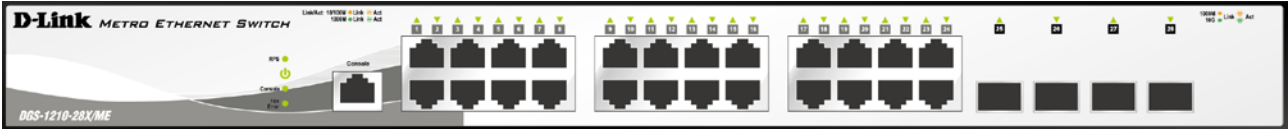

Figure 1.8 – DGS-1210-28X/ME Front Panel



CAUTION: The MiniGBIC ports should use UL listed Optical Transceiver product, Rated Laser Class I. 3.3Vdc.

The front panel of the **DGS-1210-28XS/ME** switch consists out of the following:

- 24 100/1000Mbps SFP ports
- 4 1000Mbps SFP/10G SFP+ ports
- One RJ-45 Console Port
- LEDs for Power, Console, Fan Error, RPS, Link/Act for port 1 ~ 28

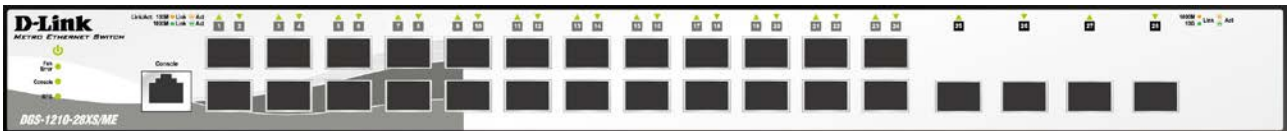

Figure 1.9 – DGS-1210-28XS/ME Front Panel



CAUTION: The MiniGBIC ports should use UL listed Optical Transceiver product, Rated Laser Class I. 3.3Vdc.

The front panel of the **DGS-1210-52/ME** switch consists out of the following:

- 48 10/100/1000Mbps Copper Ports
- 4 1000Mbps SFP port
- LEDs for Power, Console, Fan Error , RPS, Link/Act for port 1 ~ 52



Figure 1.10 – DGS-1210-52/ME Front Panel



CAUTION: The MiniGBIC ports should use UL listed Optical Transceiver product, Rated Laser Class I. 3.3Vdc.

The front panel of the **DGS-1210-52P/ME** switch consists out of the following:

- 48 10/100/1000Mbps Copper Ports
- 24 10/100/1000Mbps PoE ports
- 4 1000Mbps SFP ports
- One RJ-45 Console Port
- LEDs for Power, Console, Fan Error, PoE Max, Link/Act for port 1 ~ 52
- Mode: By pressing the Mode button, the Port LED will switch between Link/Act and PoE modes



Figure 1.11 – DGS-1210-52P/ME Front Panel

CAUTION: The MiniGBIC ports should use UL listed Optical Transceiver product, Rated Laser Class I. 3.3Vdc.

NOTE: The power budget is 193 Watts for DGS-1210-52P/ME.

The front panel of the **DGS-1210-52MP/ME** switch consists out of the following:

- 48 10/100/1000Mbps Copper and PoE Ports
- 4 1000Mbps SFP ports
- One RJ-45 Console Port
- LEDs for Power, Console, Fan Error, PoE Max, Link/Act for port 1 ~ 52
- Mode: By pressing the Mode button, the Port LED will switch between Link/Act and PoE modes



Figure 1.12 – DGS-1210-52MP/ME Front Panel

CAUTION: The MiniGBIC ports should use UL listed Optical Transceiver product, Rated Laser Class I. 3.3Vdc.

NOTE: The power budget is 370 Watts for DGS-1210-52MP/ME.

The front panel of the **DGS-1210-52MPP/ME** switch consists out of the following:

- 48 10/100/1000Mbps Copper and PoE Ports
- 4 1000Mbps SFP ports
- One RJ-45 Console Port
- LEDs for Power, Console, Fan Error, PoE Max, Link/Act for port 1 ~ 52
- Mode: By pressing the Mode button, the Port LED will switch between Link/Act and PoE modes



Figure 1.13 – DGS-1210-52MPP/ME Front Panel

CAUTION: The MiniGBIC ports should use UL listed Optical Transceiver product, Rated Laser Class I. 3.3Vdc.

NOTE: The power budget is 740 Watts for DGS-1210-52MPP/ME.

LED Indicators

The Switch supports LED indicators for Power, Console, RPS, Fan, and Link/Act for each port. The following shows the LED indicators for the DGS-1210/ME Metro Ethernet Switch along with an explanation of each indicator.

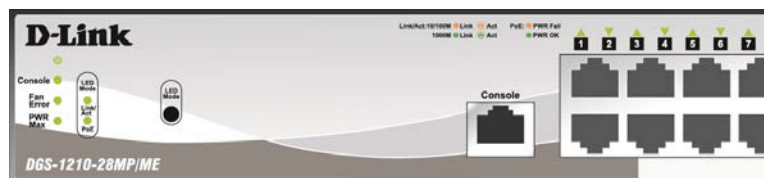

Figure 1.14 –LED Indicators on DGS-1210/ME SERIES

Location	LED Indicative	Color	Status	Description
Per Device	Power	Green	Solid Light	Power on.
			Light off	Power off.
	Console	Green	Solid Light	Console on.
			Blinking	POST is in progress.
			Light off	Console off.
	Fan Error (for DGS-1210-28P/ME, 28MP/ME, 28X/ME, 28XS/ME, 52/ME, 52P/ME, 52MP/ME, 52MPP/ME)	Red	Solid light	The fan has runtime failure and is brought offline.
	Pwr/PoE Max. (for DGS-1210-10P/ME, 28P/ME, 28MP/ME 52P/ME, 52MP/ME, 52MPP/ME)	Red	Solid light	The Pwr/PoE Max LED lights up when the total PoE output of Switch reached or exceeded 71 Watts for DGS-1210-10P/ME, 186 Watts for DGS-1210-28P/52P/ME, 363 Watts for DGS-1210-28MP/52MP/ME, and 733 Watts for DGS-1210-52MPP/ME. In the meantime, no additional PoE device can be supported.
			Light off	When the system power usage does not reach the guard band range.
	RPS (DGS-1210-10/12TS/20/28/28X/28XS/52/ME)	Green	Solid Light	RPS power on.
			Light off	RPS power off.
LED Per 10/100/1000Mbps Copper Port	Link/Act	Green / Amber	Solid Green	When there is a secure 1000Mbps Ethernet connection (or link) at any of the ports.
			Blinking Green	When there is reception or transmission (i.e. Activity-Act) of data occurring at a 1000Mbps Ethernet connected port.
			Solid Amber	When there is a secure 10/100Mbps Ethernet connection (or link) at any of the ports.
			Blinking Amber	When there is reception or transmission (i.e. Activity-Act) of data occurring at a 10/100Mbps Ethernet connected port.
			Light off	No link.
	PoE Mode	Green	Solid Light	Power feeding.
		Amber	Solid Light	Error Condition.

		Off	Solid Off	No Power feeding.
LED Per SFP Port	Link/Act	Green	Solid Green	When there is a secure 1000Mbps Ethernet connection (or link) at any of the ports.
			Blinking Green	When there is reception or transmission (i.e. Activity—Act) of data occurring at a 1000Mbps Ethernet connected port.
		Amber	Solid Light	When there is a secure 100Mbps connection at the port. (For DGS-1210-28XS/ME only)
			Blinking Amber	When there is reception or transmission occurring at the port. (For DGS-1210-28XS/ME only)
		Off	Solid off	No link.
LED Per 10G SFP+ Port (for DGS-1210-28X/ME, 28XS/ME)	Link/Act	Green	Solid Light	When there is a secure 10Gbps connection at the port.
			Blinking Green	When there is reception or transmission occurring at the port.
		Amber	Solid Light	When there is a secure 1000Mbps connection at the port.
			Blinking Amber	When there is reception or transmission occurring at the port.
		Off	Solid off	No link.

Rear Panel Description

The rear panel of the Switch contains an AC power connector. The AC power connector is a standard three-pronged connector that supports the power cord. Plug-in the female connector of the provided power cord into this socket, and the male side of the cord into a power outlet. The Switch automatically adjusts its power setting to any supply voltage in the range from 100 to 240 VAC at 50 to 60 Hz. Connect the Kensington-compatible security lock, at the rear of the switch, to a secure immovable device. Insert the lock into the notch and turn the key to secure the lock. The OFF/ON switch on the rear panel (for DGS-1210-10/12TS/20/28/28X/28XS/52/ME only) is intended to turn off the power from RPS and does NOT provide turning off the primary power source.

DGS-1210-10/ME

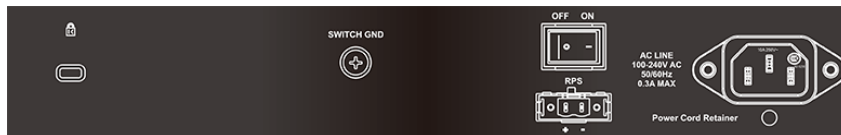

Figure 1.15 — DGS-1210-10/ME Rear Panel

DGS-1210-10P/ME



Figure 1.16 — DGS-1210-10P/ME Rear Panel

DGS-1210-12TS/ME



Figure 1.17 – DGS-1210-12TS/ME Rear Panel

DGS-1210-20/ME

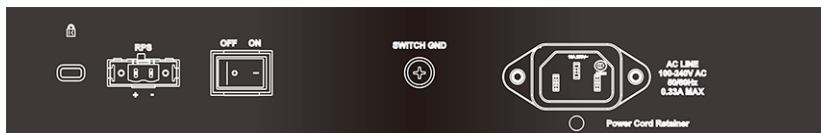

Figure 1.18 – DGS-1210-20/ME Rear Panel

DGS-1210-28/ME



Figure 1.19 – DGS-1210-28/ME Rear Panel

DGS-1210-28P/ME



Figure 1.20 – DGS-1210-28P/ME Rear Panel

DGS-1210-28MP/ME



Figure 1.21 – DGS-1210-28MP/ME Rear Panel

DGS-1210-28X/ME



Figure 1.22 – DGS-1210-28X/ME Rear Panel

DGS-1210-28XS/ME



Figure 1.23 – DGS-1210-28XS/ME Rear Panel

DGS-1210-52/ME



Figure 1.24 — DGS-1210-52/ME Rear Panel

DGS-1210-52P/ME



Figure 1.25 — DGS-1210-52P/ME Rear Panel

DGS-1210-52MP/ME



Figure 1.26 — DGS-1210-52MP/ME Rear Panel

DGS-1210-52MPP/ME



Figure 1.27 — DGS-1210-52MPP/ME Rear Panel

Side Panel Description

The left- and right-hand panels of the Switch have heat vents to dissipate heat. Do not block these openings, and leave at least 6 inches of space at the rear and sides of the Switch for proper ventilation. Be reminded that without proper heat dissipation and air circulation, system components might overheat, which could lead to system failure.



Figure 1.28 - Side panels of the DGS-1210/ME SERIES

Gigabit Fiber Ports

The DGS-1210/ME Series features support four Small Form Factor Portable (SFP) ports (optional). See the diagram below to view the four SFP port modules being plugged into the Switch.

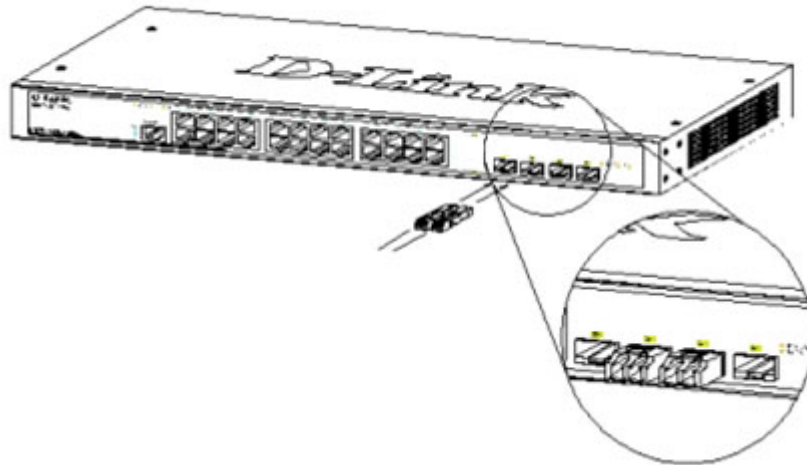

Figure 1.29 - Inserting the SFP modules into the Switch

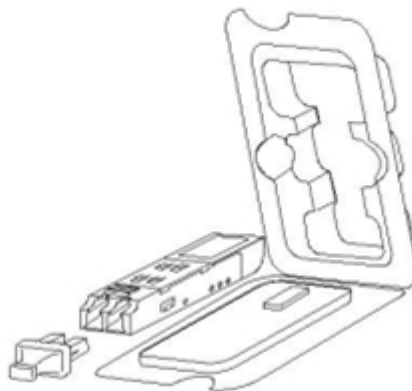

Figure 1.30- Installing the SFP Module

The Switch is equipped with SFP ports, which are to be used with fiber-optical transceiver cabling in order to uplink various other networking devices for a gigabit link that may span great distances.

Connecting the DPS-200A/500A/500DC to the RPS Port (for DGS-1210-10/12TS/20/28/28X/28XS/52/ME only)

The DPS-200A/500A/500DC redundant power supply can be connected to the RPS port of the Switch using the DC power supply cord, called the DPS-CB150-2PS. It is important to notice that the DPS-200A/500A/500DC can supply power to one or two devices at the same time.

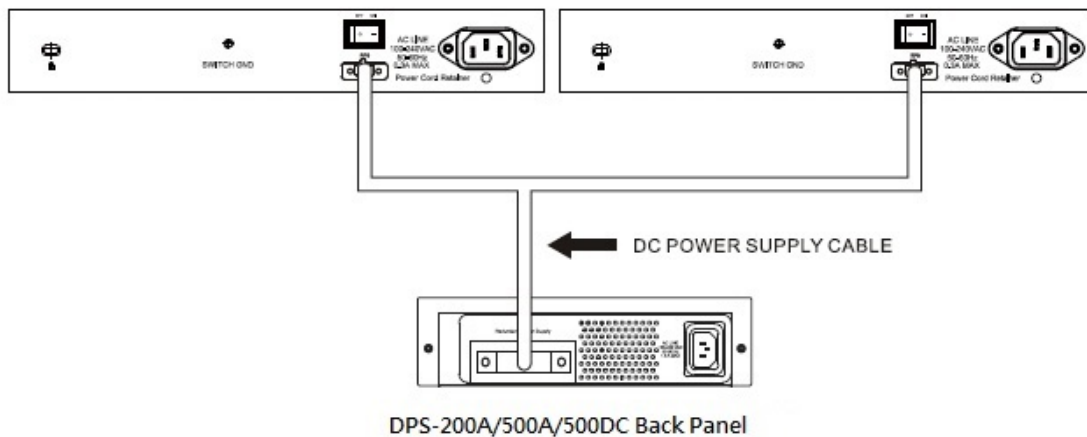

Figure 1.31 – Connecting two Switches to the DPS-200A/500A/500DC

The following section explains how to connect the DPS-200A/500A/500DC to the Switch.

- Disconnect the Switch from the main AC power source.
- Insert the 14-pin end of the DPS-CB150-2PS into the DPS-200A/500A/500DC and the 2-pin end into the receptacle of the RPS port on the Switch.
- Using a standard AC power cord, connect the DPS-200A/500A/500DC to the main AC power source. A green LED on the front panel of the DPS-200A/500A/500DC will illuminate to indicate a successful connection.
- Make sure that the ON/OFF toggle switch on the rear panel of the Switch is turned on.
- Re-connect the Switch to the AC power source and power on the 200A/500A/500DC.

No configuration is needed in the Switch software for this installation.



NOTE: See the DPS- DPS-200A/500A/500DC Quick Installation Guide for more information.

Installing the RPS into a Rack-mount Chassis (for DGS-1210-10/12TS/20/28/28X/28XS/52/ME only)

The DPS-200A/500A/500DC are the redundant power supply units designed to conform to the voltage requirements of the RPS port of the Switch being supported. The DPS-200A/500A/500DC can be installed into a DPS-800 rack-mount chassis unit.



CAUTION: DO NOT connect the RPS to the AC power before the DC power cable is connected. Connecting the AC power before the DC power is connected might damage the internal power supply.

DPS-800 Rack-mount Chassis

The DPS-800 is a standard-size rack-mount (1 standard unit in height) designed to hold up to three DPS-200A/500A/500DC redundant power supplies.

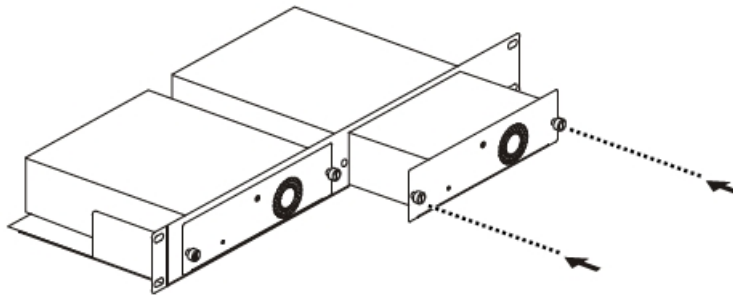

Figure 1.32 –Installing the DPS-200A/500A/500DC in the DPS-800

The DPS-800 rack-mount chassis can be mounted into a standard 19" rack. Use the following diagram to guide you.

2 Installation

This chapter provides unpacking and installation information for the D-Link Metro Ethernet Switch.

Step 1: Package Contents

Open the shipping carton and carefully unpack its contents. Please consult the packing list located in the User Manual to make sure all items are present and undamaged. If any item is missing or damaged, please contact your local D-Link reseller for replacement.

- › One D-Link Metro Ethernet Switch
- › One multi-language Getting Started Guide
- › One CD
- › One RJ-45 console cable
- › Power cord clip
- › Power cord
- › Rack mount kit
- › Rubber feet

If any item is found missing or damaged, please contact the local reseller for replacement.

Step 2: Installation Guidelines

For safe switch installation and operation, it is recommended that you:

- › Visually inspect the power cord to see that it is secured fully to the AC power connector.
- › Make sure that there is proper heat dissipation and adequate ventilation around the switch.
- › Do not place heavy objects on the switch.

Desktop or Shelf Installation

When installing the switch on a desktop or shelf, the rubber feet included with the device must be attached on the bottom at each corner of the device's base. Allow enough ventilation space between the device and the objects around it.

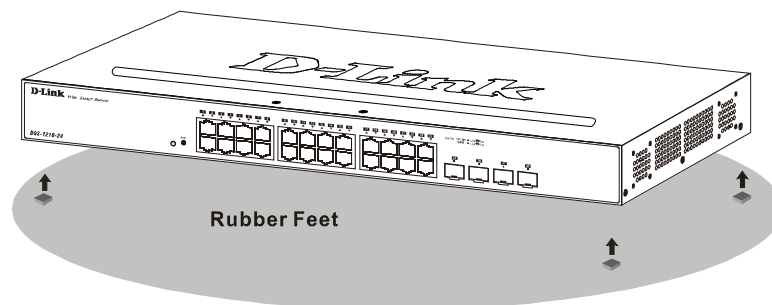

Figure 2.1 – Attach the adhesive rubber pads to the bottom

Rack Installation

The switch can be mounted in an EIA standard size 19-inch rack, which can be placed in a wiring closet with other equipment. To install, attach the mounting brackets to the switch's side panels (one on each side) and secure them with the screws provided (please note that these brackets are not designed for palm size switches).

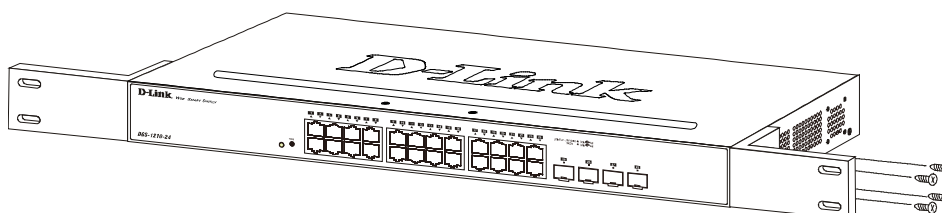

Figure 2.2 – Attach the mounting brackets to the Switch

Then, use the screws provided with the equipment rack to mount the switch in the rack.

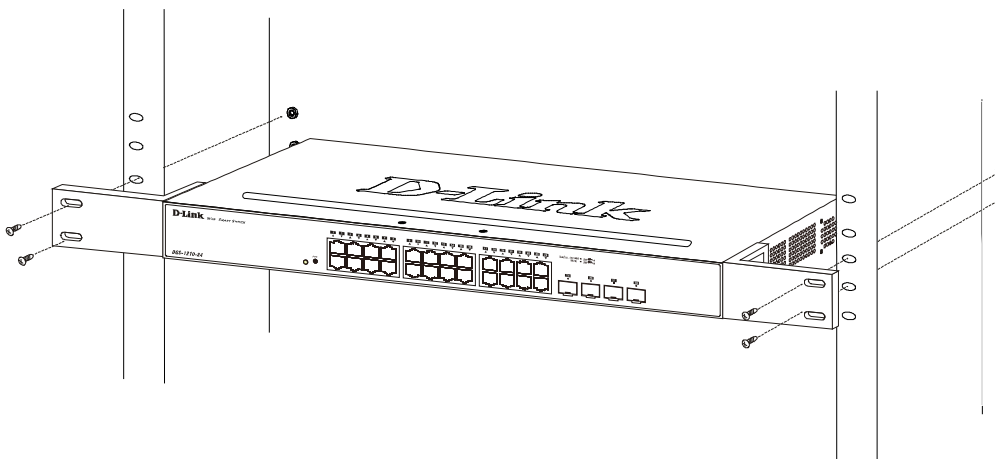

Figure 2.3 – Mount the Switch in the rack or chassis

Please be aware of following safety Instructions when installing:

A) Elevated Operating Ambient - If installed in a closed or multi-unit rack assembly, the operating ambient temperature of the rack environment may be greater than room ambient. Therefore, consideration should be given to installing the equipment in an environment compatible with the maximum ambient temperature (T_{ma}) specified by the manufacturer.

B) Reduced Air Flow - Installation of the equipment in a rack should be such that the amount of air flow required for safe operation of the equipment is not compromised.

C) Mechanical Loading - Mounting of the equipment in the rack should be such that a hazardous condition is not achieved due to uneven mechanical loading.

D) Circuit Overloading - Consideration should be given to the connection of the equipment to the supply circuit, and the effect that overloading of the circuits might have on overcurrent protection and supply wiring. Appropriate consideration of equipment nameplate ratings should be used when addressing this concern.

E) Reliable Earthing - Reliable earthing of rack-mounted equipment should be maintained. Particular attention should be given to supply connections other than direct connections to the branch circuit (e.g. use of power strips)."

Step 3 – Plugging in the AC Power Cord

Users may now connect the AC power cord into the rear of the switch and to an electrical outlet (preferably one that is grounded and surge protected).

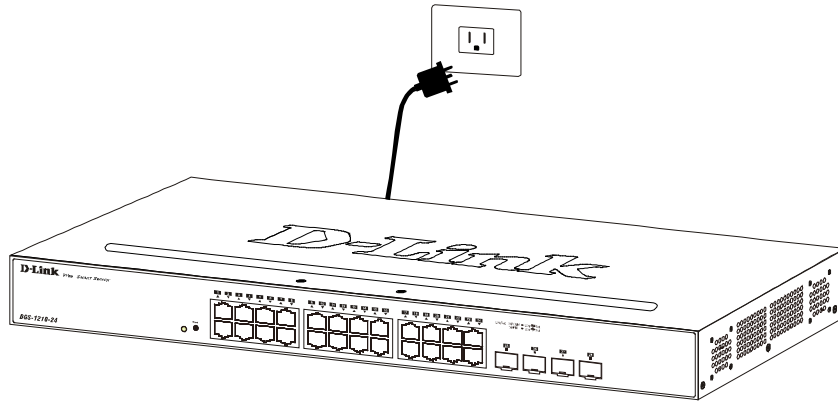

Figure 2.4 – Plugging the switch into an outlet

Power Failure

As a precaution, the switch should be unplugged in case of power failure. When power is resumed, plug the switch back in.

3 Switch Management

This chapter introduces the management interface of D-Link DGS-1210/ME Metro Ethernet Switch.

- **Management Options**
- **Using Web-based Management**
- **Connecting to the Console Port**

Management Options

The D-Link Metro Ethernet Switch can be managed through any port on the device by using the Web-based Management or command line interface.

Each switch must be assigned its own IP Address, which is used for communication with the Web-Based Management or a SNMP network manager. The PC should have an IP address in the same range as the switch. Each switch can allow up to four users to access the Web-Based Management concurrently.

Please refer to the following installation instructions for the Web-based Management.

Using Web-based Management

After a successful physical installation, you can configure the Switch, monitor the network status, and display statistics using a web browser.

Supported Web Browsers

The embedded Web-based Management currently supports the following web browsers:

- Microsoft Internet Explorer 10/11
- Microsoft Edge 25
- Chrome 51
- Safari 5.1.7

Connecting to the Switch

You will need the following equipment to begin the web configuration of your device:

1. A PC with a RJ-45 Ethernet connection
2. A standard Ethernet cable

Connect the Ethernet cable to any of the ports on the front panel of the switch and to the Ethernet port on the PC.

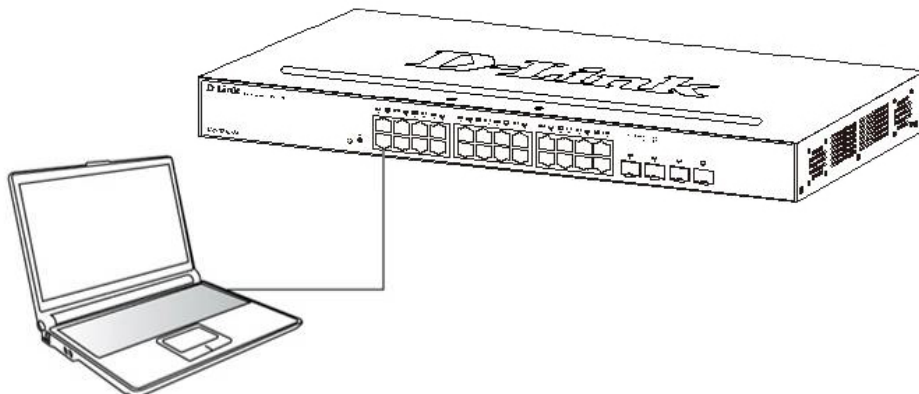

Figure 3.1 – Connected Ethernet cable

Login Web-based Management

In order to login and configure the switch via an Ethernet connection, the PC must have an IP address in the same subnet as the switch. For example, if the switch has an IP address of **10.90.90.90**, the PC should have an IP address of **10.x.y.z** (where x/y is a number between 0 ~ 254 and z is a number between 1 ~ 254), and a subnet mask of **255.0.0.0**. Enter 10.90.90.90 (the factory default IP address) in the address bar of your web browser and press <Enter>.

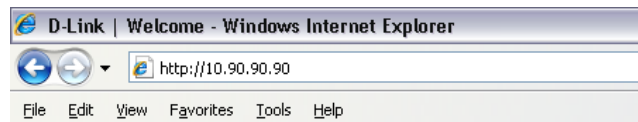

Figure 3.2 –Enter the IP address 10.90.90.90 in the web browser



NOTE: The switch's factory default IP address is 10.90.90.90 with a subnet mask of 255.0.0.0 and a default gateway of 0.0.0.0.

When the following logon dialog box appears, enter the password and choose the language of the Web-based Management interface then click **OK**.

By default, the Username and Password are empty.



Figure 3.3 – Logon Dialog Box

Connecting the Console Port

The console port on the front panel of the Switch is used to connect a computer that monitors and configures the switch. The console port is an RJ-45 port and requires a special cable that is included with the switch, to establish the physical connection.

To connect a terminal to the console port

The console interface is used by connecting the Switch to a VT100-compatible terminal or a computer running an ordinary terminal emulator program (for example, the HyperTerminal program included with the Windows operating system) using an RJ-45 serial cable. Your terminal parameters will need to be set to:

- VT-100 compatible
- Baud rate 9600bps
- 8 data bits
- No parity
- One stop bit
- No flow control

The same functions may also be accessed over a Telnet interface. Once an IP address for the Switch has been set, A Telnet program can be used (in VT-100 compatible terminal mode) to access and control the Switch. All of the screens are identical, whether accessed from the console port or from a Telnet interface. After the Switch reboots and you have to logged in, the console looks like this:

```

DGS-1210-28/ME Gigabit Ethernet Switch
Command Line Interface

Firmware: Build 7.00.076
Copyright (C) 2012 D-Link Corporation. All rights reserved.

UserName: █

```

Figure 3.4 Initial Console Screen after Logging In

Password Protection

The DGS-1210/ME Series Switches do not have a password. One of the first tasks when settings up the Switch is to create user accounts. Logging in using a predefined administrator-level user name will give the user privileged access to the Switch's management software.

After the initial login, define new passwords for both default user names to prevent unauthorized access to the Switch, and record the passwords for future reference.

To create an administrator-level account for the Switch, do the following:

1. At the CLI login prompt, enter **create account admin** followed by the <username> and press the Enter key.
2. The Switch will then prompt the user to provide a password. Type the administrator <password> and press the Enter key.
3. Once entered, the Switch will again ask the user to insert the same password again to verify it. Type the same password and press the Enter key.
4. A new administrative account is created once the "Success" prompt appears.



NOTE: Passwords are case sensitive. User names and passwords can be up to 15 characters in length.

The sample below illustrates a successful creation of a new administrator-level account with the user name "newmanager".

```

DGS-1210-28MP/ME:5# create account admin newmanager

Command: create account admin newmanager

Enter a case-sensitive new password:****
Enter the new password again for confirmation:****

Success.

DGS-1210-28MP/ME:5#

```

Figure 3.5 Create new account



NOTE: CLI configuration commands only modify the running configuration file and are not saved when the Switch is rebooted. To save all your configuration changes in nonvolatile storage, you must use the save command to copy the running configuration file to the startup configuration.

Assigning IP Addresses

Each Switch must be assigned its own IP Address, which is used for communication with an SNMP network manager or other TCP/IP application (for example BOOTP, TFTP). The Switch's default IP address is 10.90.90.90. You can change the default Switch IP address to meet the specification of your networking address scheme.

The Switch is also assigned a unique MAC address by the factory. This MAC address cannot be changed, and can be found by entering the command **show switch** into the command line interface, as shown below.

```

DGS-1210-28MP/ME:5# show switch

Command: show switch

Device Type           : DGS-1210-28MP/ME
MAC Address           : 00-01-02-03-04-05
IP Address             : 10.90.90.90 (Manual)
VLAN Name              : default
Subnet Mask            : 255.0.0.0
Default Gateway        : 0.0.0.0
System Boot Version    : 1.01.033
System Firmware Version : 7.01.B030
System Hardware Version : B1
System Serial Number   : QBDGS12102800
System Name            :
System Location         :
System up time         : 0 days, 0 hrs, 1 min, 2 secs
System Contact         :
System Time             : 12/08/2016 15:26:11
RTC Time               : 12/08/2016 15:26:11
STP                    : Disabled
GVRP                   : Disabled
IGMP Snooping          : Disabled
VLAN Trunk              : Disabled
802.1X Status          : Disabled

DGS-1210-28MP/ME:5#

```

Figure 3.6 Show switch command

The Switch's MAC address can also be found from the Web management program on the **System Information window** in the Configuration folder.

The IP address for the Switch must be set before it can be managed with the Web-based manager. The Switch IP address can be automatically set using BOOTP or DHCP protocols, in which case the actual address assigned to the Switch must be known.

The IP address may be set using the Command Line Interface (CLI) over the console serial port as follows: Starting at the command line prompt, enter the commands `config ipif System ipaddress xxx.xxx.xxx.xxx/yyy.yyy.yyy.yyy`

Where the x's represent the IP address to be assigned to the IP interface named System and the y's represent the corresponding subnet mask.

Alternatively, you can enter `config ipif System ipaddress xxx.xxx.xxx.xxx/z`. Where the x's represent the IP address to be assigned to the IP interface named System and the z represents the corresponding number of subnets in CIDR notation.

The IP interface named System on the Switch can be assigned an IP address and subnet mask, and then be used to connect a management station to the Switch's Telnet or Web-based management agent.

```
DGS-1210-28MP/ME:5# config ipif System ipaddress 10.90.90.91/255.0.0.0
Command: config ipif System ipaddress 10.90.90.91/255.0.0.0

Success.

DGS-1210-28MP/ME:5#
```

Figure 3.7 Assigning the Switch an IP address

In the above example, the Switch was assigned an IP address of 10.90.90.91 with a subnet mask of 255.0.0.0. (the CIDR form was used to set the address (10.90.90.91/8). The system message Success indicates that the command was executed successfully. The Switch can now be configured and managed via Telnet and the CLI or via the Web-based management.

SNMP Settings

Each Switch must be assigned its own IP Address, which is used for communication with an SNMP network manager. Simple Network Management Protocol (SNMP) is an OSI Layer 7 (Application Layer) designed specifically for managing and monitoring network devices. SNMP enables network management stations to read and modify the settings of gateways, routers, switches and other network devices. Use SNMP to configure system features for proper operation, monitor performance and detect potential problems in the Switch, switch group or network.

Managed devices that support SNMP include software (referred to as an agent), which runs locally on the device. A defined set of variables (managed objects) is maintained by the SNMP agent and used to manage the device. These objects are defined in a Management Information Base (MIB), which provides a standard presentation of the information controlled by the on-board SNMP agent. SNMP defines both the format of the MIB specifications and the protocol used to access this information over the network.

The Switch supports SNMP versions 1, 2c, and 3. The administrator may specify which SNMP version to use to monitor and control the Switch. The three SNMP versions vary in the level of security provided between the management station and the network device.

In SNMP v1 and v2, user authentication is accomplished using 'community strings', which function like passwords. The remote user SNMP application and the Switch SNMP must use the same community string. SNMP packets from any station that has not been authenticated are ignored (dropped).

The default community strings for the Switch used for SNMP v1 and v2 management access are:

- public - Allows authorized management stations to retrieve MIB objects.
- private - Allows authorized management stations to retrieve and modify MIB objects.

SNMP v3 uses a more sophisticated authentication process that is separated into two parts. The first part is to maintain a list of users and their attributes that are allowed to act as SNMP managers. The second part

describes what each user on that list can do as an SNMP manager.

The Switch allows groups of users to be listed and configured with a shared set of privileges. The SNMP version may also be set for a listed group of SNMP managers. Thus, a group of SNMP managers can be created to view read-only information or receive traps using SNMP v1 while assigning a higher level of security to another group, granting read/write privileges using SNMP v3.

Using SNMP v3 individual users or groups of SNMP managers can be allowed to perform or be restricted from performing specific SNMP management functions. The functions allowed or restricted are defined using the Object Identifier (OID) associated with a specific MIB. An additional layer of security is available for SNMP v3 in that SNMP messages may be encrypted. To read more about how to configure SNMP v3 settings for the Switch read the section entitled Management.

Traps

Traps are messages that alert network personnel of events that occur on the Switch. The events can be as serious as a reboot (someone accidentally turned OFF the Switch), or less serious like a port status change. The Switch generates traps and sends them to the trap recipient (or network manager). Typical traps include trap messages for Authentication Failure, Topology Change and Broadcast\Multicast Storm.

Management Information Base (MIB)

The Switch in the Management Information Base (MIB) stores management and counter information. The Switch uses the standard MIB-II Management Information Base module. Consequently, values for MIB objects can be retrieved from any SNMP-based network management software. In addition to the standard MIB-II, the Switch also supports its own proprietary enterprise MIB as an extended Management Information Base. The proprietary MIB may also be retrieved by specifying the MIB Object Identifier. MIB values can be either read-only or read-write.

4 Web-based Switch Configuration

- **Logging onto the Web Manager**
- **Web-based User Interface**
- **Areas of the User Interface**
- **Web Pages**

Logging onto the Web Manager

In order to login and configure the switch via an Ethernet connection, the PC must have an IP address in the same subnet as the switch. For example, if the switch has an IP address of **10.90.90.90**, the PC should have an IP address of **10.x.y.z** (where x/y is a number between 0 ~ 254 and z is a number between 1 ~ 254), and a subnet mask of **255.0.0.0**. Enter 10.90.90.90 (the factory default IP address) in the address bar of your web browser and press <Enter>.

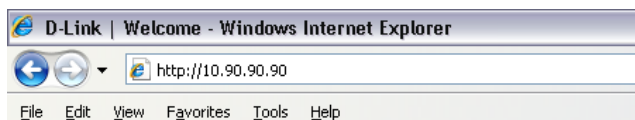

Figure 4.1 –Enter the IP address 10.90.90.90 in the web browser



NOTE: The switch's factory default IP address is 10.90.90.90 with a subnet mask of 255.0.0.0 and a default gateway of 0.0.0.0.

When the following logon dialog box appears, enter the password and choose the language of the Web-based Management interface then click **OK**.

By default, the Username and Password are empty.



Figure 4.2 – Logon Dialog Box

Web-based User Interface

The user interface provides access to various Switch configuration and management windows, it allows the user to view performance statistics, and permits graphical monitoring of the system status.

Areas of the User Interface

The figure below shows the user interface. Three distinct areas divide the user interface, as described in the table.

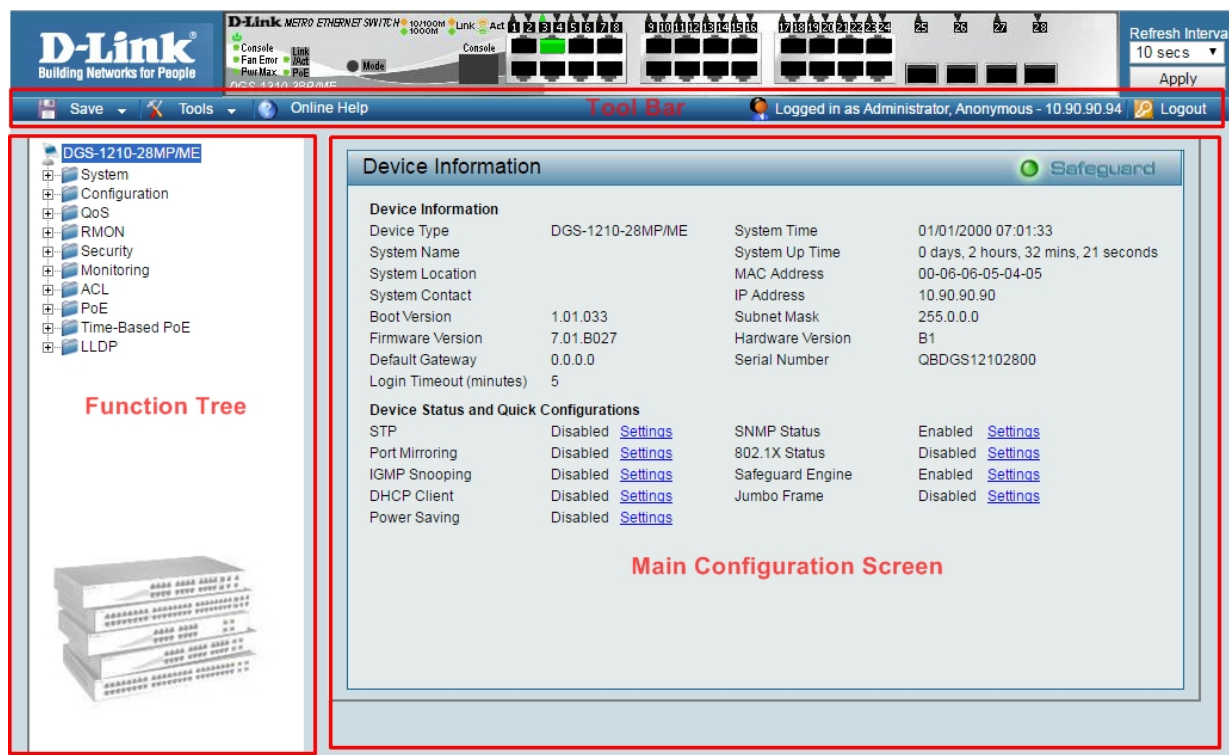

Figure 4.3 Main Web-manager Window

Area	Function
Function Tree	Select the folder or window to display. Open folders and click the hyperlinked window buttons and subfolders contained within them to display windows.
Tool Bar	Presents a graphical near real-time image of the front panel of the Switch. This area displays the Switch's ports and expansion modules and shows port activity, depending on the specified mode. Some management functions, including port monitoring are accessible here. Click the D-Link logo to go to the D-Link Website.
Main Configuration Screen	Presents Switch status based on user selection and the entry of configuration data. In addition, hyperlinks are offered for many Switch features to enable quick configuration.

Web Pages

When connecting to the management mode of the Switch with a Web browser, a login screen is displayed. Enter a user name and password to access the Switch's management mode.

Below is a list of the main folders available in the Web interface:

- **System** - In this section the user will be able to configure features regarding the Switch's system.
- **Configuration** - In this section the user will be able to configure features regarding the Switch's configuration.
- **QoS** - In this section the user will be able to configure features regarding the Quality of Service functionality of the Switch.
- **RMON** - In this section the user will be able to configure features regarding the Switch's RMON.
- **Security** - In this section the user will be able to configure features regarding the Switch's security.
- **Monitoring** - In this section the user will be able to monitor the Switch's configuration and statistics.
- **ACL** - In this section the user will be able to configure features regarding the Access Control List functionality of the Switch.

PoE – In this section the user will be able to configure features regarding the Power over Ethernet functionality of the Switch.

- **Time-Based PoE** – In this section the user will be able to configure features regarding the Time-Based PoE of Power over Ethernet functionality of the Switch.
- **LLDP** - In this section the user will be able to configure features regarding the LLDP functionality of the Switch.

Appendix A – Ethernet Technology

The appendix contains the device specifications, and contains the topics:

- Technical Specifications
- Supported Transceivers

Technical Specifications

Performance	
Transmission Method	Store-and-forward
Switching Capacity	DGS-1210-10/ME: 20Gbps DGS-1210-10P/ME: 20Gbps DGS-1210-12TS/ME: 24Gbps DGS-1210-20/ME: 40Gbps DGS-1210-28/ME: 56Gbps DGS-1210-28P/ME: 56Gbps DGS-1210-28MP/ME: 56Gbps DGS-1210-28X/ME: 128Gbps DGS-1210-28XS/ME: 128Gbps DGS-1210-52/ME: 104Gbps DGS-1210-52P/ME: 104Gbps DGS-1210-52MP/ME: 104Gbps DGS-1210-52MPP/ME: 104Gbps
Packet Buffer memory	DGS-1210-10/ME: 1.5Mbytes DGS-1210-10P/ME: 1.5Mbytes DGS-1210-12TS/ME: 1.5Mbytes DGS-1210-20/ME: 1.5Mbytes DGS-1210-28/ME: 1.5Mbytes DGS-1210-28P/ME: 1.5Mbytes DGS-1210-28MP/ME: 1.5Mbytes DGS-1210-28X/ME: 1.5Mbytes DGS-1210-28XS/ME: 1.5Mbytes DGS-1210-52/ME: 3.0Mbytes DGS-1210-52P/ME: 3.0Mbytes DGS-1210-52MP/ME: 3.0Mbytes DGS-1210-52MPP/ME: 3.0Mbytes
64 Bytes Max. Packet Forwarding Rate	Full-wire speed for all connections. DGS-1210-10/ME: 14.88 Mpps DGS-1210-10P/ME: 14.88 Mpps DGS-1210-12TS/ME: 23.8 Mpps DGS-1210-20/ME: 29.8 Mpps DGS-1210-28/ME: 41.7 Mpps DGS-1210-28P/ME: 41.7 Mpps DGS-1210-28MP/ME: 41.7 Mpps DGS-1210-28X/ME: 95.24 Mpps DGS-1210-28XS/ME: 95.24 Mpps DGS-1210-52/ME: 77.4 Mpps DGS-1210-52P/ME: 77.4 Mpps DGS-1210-52MP/ME: 77.4 Mpps

Performance	
	DGS-1210-52MPP/ME: 77.4 Mpps
MAC Address Learning	Automatic update. Supports 16K MAC address.
DRAM	256 MB – DDR3
Flash Memory	32 MB – SPI flash
Priority Queues	8 Priority Queues per port.
Forwarding Table Age Time	Max age: 10–600 seconds. Default = 300.

Physical and Environmental	
AC Inputs	<p>DGS-1210-10/ME: AC Input: 100 – 240 VAC, 50-60 Hz, Max. 0.3A</p> <p>DGS-1210-10P/ME: AC Input: 100 – 240 VAC, 50-60 Hz, Max. 1.3A</p> <p>DGS-1210-12TS/ME: AC Input: 100 – 240 VAC, 50-60 Hz, Max. 0.4A</p> <p>DGS-1210-20/ME: AC Input: 100 – 240 VAC, 50-60 Hz, Max. 0.33A</p> <p>DGS-1210-28/ME: AC Input: 100 – 240 VAC, 50-60 Hz, Max. 0.43A</p> <p>DGS-1210-28P/ME: AC Input: 100 – 240 VAC, 50-60 Hz, Max. 3.05A</p> <p>DGS-1210-28MP/ME: AC Input: 100 – 240 VAC, 50-60 Hz, Max. 5.48A</p> <p>DGS-1210-28X/ME: AC Input: 100 – 240 VAC, 50-60 Hz, Max. 0.58A</p> <p>DGS-1210-28XS/ME: AC Input: 100 – 240 VAC, 50-60 Hz, Max. 0.98A</p> <p>DGS-1210-52/ME: AC Input: 100 – 240 VAC, 50-60 Hz, Max. 0.7A</p> <p>DGS-1210-52P/ME: AC Input: 100 – 240 VAC, 50-60 Hz, Max. 3.36A</p> <p>DGS-1210-52MP/ME: AC Input: 100 – 240 VAC, 50-60 Hz, Max. 5.78A</p> <p>DGS-1210-52MPP/ME: AC Input: 100 – 240 VAC, 50-60 Hz, Max. 10A</p>

Physical and Environmental	
Power Consumption	<p>DGS-1210-10/ME: Maximum power consumption: 13.59Watts Standby power consumption: 9.4Watts</p> <p>DGS-1210-10P/ME: Maximum power consumption: 103.4Watts (PoE on), 17.9Watts (PoE off) Standby power consumption: 11.1Watts</p> <p>DGS-1210-12TS/ME: Maximum power consumption: 13.85Watts Standby power consumption: 7.49Watts</p> <p>DGS-1210-20/ME: Maximum power consumption: 13.97Watts Standby power consumption: 6.95Watts</p> <p>DGS-1210-28/ME: Maximum power consumption: 19.14Watts Standby power consumption: 8.21Watts</p> <p>DGS-1210-28P/ME: Maximum power consumption: 251.5Watts (PoE on), 28.7Watts (PoE off) Standby power consumption: 18.4Watts</p> <p>DGS-1210-28MP/ME: Maximum power consumption: 455Watts (PoE on), 35.6Watts (PoE off) Standby power consumption: 23.5Watts</p> <p>DGS-1210-28X/ME: Maximum power consumption: 24.5Watts Standby power consumption: 13Watts</p> <p>DGS-1210-28XS/ME: Maximum power consumption: 33.4Watts Standby power consumption: 16.7Watts</p> <p>DGS-1210-52/ME : Maximum power consumption: 38.85Watts Standby power consumption: 21.72Watts</p> <p>DGS-1210-52P/ME: Maximum power consumption: 273.2Watts (PoE on), 47.9Watts (PoE off) Standby power consumption: 32Watts</p> <p>DGS-1210-52MP/ME:</p>

Physical and Environmental	
	<p>Maximum power consumption: 479.5Watts (PoE on), 54.4Watts (PoE off) Standby power consumption: 33Watts</p> <p>DGS-1210-52MPP/ME: Maximum power consumption: 957.9Watts (PoE on), 56.8Watts (PoE off) Standby power consumption: 37.8Watts</p>
Fans	<p>DGS-1210-10/ME: Fanless DGS-1210-10P/ME: Fanless DGS-1210-12TS/ME: Fanless DGS-1210-20/ME: Fanless DGS-1210-28/ME: Fanless DGS-1210-28P/ME: 2pcs Smart fan DGS-1210-28MP/ME: 3pcs Smart fan DGS-1210-28X/ME: 1pcs Smart fan DGS-1210-28XS/ME: 2pcs Smart fan DGS-1210-52/ME: 1pcs Smart Fan DGS-1210-52P/ME: 2pcs Smart Fan DGS-1210-52MP/ME: 3pcs Smart Fan DGS-1210-52MPP/ME: 5pcs Smart Fan</p>
Operating Temperature	-30 to 50 degrees Celsius
Storage Temperature	-40 to 70 degrees Celsius
Humidity	Storage: 5% to 90% non-condensing
Dimensions	<p>11-inch, 1U Rack-mount size: - DGS-1210-10/ME: 280mm x 126mm x 44mm - DGS-1210-10P/12TS/20/ME: 280mm x 180mm x 44 mm</p> <p>19-inch, 1U Rack-mount size: - DGS-1210-28/ME: 440 x 140 x 44 mm - DGS-1210-28P/28X/28XS/52/ME: 440 x 210 x 44 mm - DGS-1210-28MP/ME: 440 x 250 x 44 mm - DGS-1210-52P/52MP/52MPP/ME: 440 x 430 x 44 mm</p>
Weight	<p>DGS-1210-10/ME: 1.05 kg DGS-1210-10P/ME: 1.92 kg DGS-1210-12TS/ME: 1.17 kg DGS-1210-20/ME: 1.38 kg DGS-1210-28/ME: 2.21 kg DGS-1210-28P/ME: 3.34 kg DGS-1210-28MP/ME: 3.96 kg DGS-1210-28X/ME: 2.68 kg DGS-1210-28XS/ME: 2.96 kg DGS-1210-52/ME: 3.31 kg DGS-1210-52P/ME: 5.72 kg DGS-1210-52MP/ME: 6.04 kg DGS-1210-52MP/ME: 6.52 kg</p>
EMI	CE, FCC, VCCI, BSMI

Physical and Environmental	
	CE (DGS-1210-28X/ME, 28XS/ME only)
Safety	UL, CB, LVD, BSMI UL, CB, LVD (DGS-1210-28X/ME, 28XS/ME only)

General	
Number of Ports:	<p>DGS-1210-10/ME: 8-Ports 10/100/1000Mbps + 2-Ports 1000Mbps SFP</p> <p>DGS-1210-10P/ME: 8-Ports PoE 10/100/1000Mbps + 2-Ports 1000Mbps SFP</p> <p>DGS-1210-12TS/ME: 10-Ports 1000Mbps SFP + 2-Ports 10/100/1000Mbps</p> <p>DGS-1210-20/ME: 16-Ports 10/100/1000Mbps + 4-Ports 1000Mbps SFP</p> <p>DGS-1210-28/ME: 24-Ports 10/100/1000Mbps + 4-Ports 1000Mbps SFP</p> <p>DGS-1210-28P/ME: 24-Ports PoE 10/100/1000Mbps + 4-Ports 1000Mbps SFP</p> <p>DGS-1210-28MP/ME: 24-Ports PoE 10/100/1000Mbps + 4-Ports 1000Mbps SFP</p> <p>DGS-1210-28X/ME: 24-Ports 10/100/1000Mbps + 4-Ports 10G SFP+</p> <p>DGS-1210-28XS/ME: 24-Ports 100/1000Mbps SFP + 4-Ports 10G SFP+</p> <p>DGS-1210-52/ME: 48-Ports 10/100/1000Mbps + 4-Ports 1000Mbps SFP</p> <p>DGS-1210-52P/ME: 48-Ports 10/100/1000Mbps with 24-Ports PoE 10/100/1000Mbps + 4-Ports 1000Mbps SFP</p> <p>DGS-1210-52MP/ME: 48-Ports PoE 10/100/1000Mbps + 4-Ports 1000Mbps SFP</p> <p>DGS-1210-52MPP/ME: 48-Ports PoE 10/100/1000Mbps + 4-Ports 1000Mbps SFP</p>

Standards	<ul style="list-style-type: none"> IEEE 802.3 10BASE-T Ethernet IEEE 802.3u 100BASE-TX Fast Ethernet IEEE 802.3ab 1000BASE-T Gigabit Ethernet IEEE 802.3ae 10 Gigabit Ethernet (for 28X/ME, 28XS/ME) IEEE 802.3u 100BASE-FX (for 28XS/ME) IEEE 802.3z 1000BASE-X Gigabit Fiber (for 28XS/ME, 12TS/ME) IEEE 802.3x Flow Control for full-duplex mode, auto-negotiation
Protocols	CSMA/CD
Duplex Mode	Full/half-duplex for 10/100Mbps and full-duplex for 1000Mbps speed
Topology	Star

Optional DC Primary Power Supply (Non-PoE Models Only)	
SF24-2120200-1C	Input voltage: 72V DC to 36V DC, output voltage: 12V/2A (for DGS-1210-ME, 20/ME, 28/ME B1)
SE40-1120333-3C	Input voltage: 72V DC to 36V DC, output voltage: 12V/3.33A (for DGS-1210-52/ME B1)

Network Cables
· UTP Cat. 3, Cat. 4, Cat. 5, Cat. 5e (100m max.) · EIA/TIA-568 150-ohm STP (100m max.)

Redundant Power Supply (for DGS-1210-10/ME, 12TS/ME, 20/ME, 28/ME, 28X/ME, 28XS/ME, 52/ME only)	
DPS-200A	Redundant Power Supply DPS-200A
DPS-500A	Redundant Power Supply DPS-500A
DPS-500DC	Redundant Power Supply DPS-500DC
DPS-CB150-2PS	150cm RPS cable for connecting DGS-1210-10/ME, 12TS/ME, 20/ME, 28/ME, 28X/ME, 28XS/ME, 52/ME, and DPS-200A/500A/500DC
SU54-21124-000S	Optional 54 W AC to DC Power Supply Unit with external lead-acid battery support that can be used as a redundant power supply or to connect an external 12 V DC lead-acid battery to charge the switch. The minimum requirement voltage for the lead-acid battery is 12 V DC, with a minimum capacity of 2 AH (for DGS-1210-10/ME, 20/ME, 28/ME, 52/ME).

Supported Transceivers

Optional SFP Transceivers	
DEM-310GT	1000BASE-LX, Single-mode, 10 km
DEM-311GT	1000BASE-SX, Multi-mode, 500 m
DEM-312GT2	1000BASE-SX, Multi-mode, 2 km
DEM-312GT2	1000BASE-LHX, Single-mode, 50 km

Optional SFP Transceivers	
DEM-315GT	1000BASE-ZX, Single-mode, 80 km
DGS-712	1000BASE-T 100 m (only supports 1000 Mbps mode) (no flow control)
DEM-302S-LX	1000BASE-LX, Single-mode, 2 km
DEM-210	100BASE-FX, Single-mode, 15 km (for DGS-1210-28XS/ME only)
DEM-211	100BASE-FX, Multi-mode, 2 km (for DGS-1210-28XS/ME only)

Optional WDM SFP Transceivers	
DEM-330T	1000BASE-LX, Single-mode, 10 km, Tx: 1550, Rx: 1310 nm
DEM-330R	1000BASE-LX, Single-mode, 10 km, Tx: 1310, Rx: 1550 nm
DEM-331T	1000BASE-LX, Single-mode, 40 km, Tx: 1550, Rx: 1310 nm
DEM-331R	1000BASE-LX, Single-mode, 40 km, Tx: 1310, Rx: 1550 nm
DEM-302S-BXD	1000BASE-LX, Single-mode, 2 km, Tx: 1550, Rx: 1310 nm
DEM-302S-BXU	1000BASE-LX, Single-mode, 2 km, Tx: 1310, Rx: 1550 nm
DEM-220T	100BASE-BX, Single-mode, 20 km, Tx: 1550, Rx: 1310 nm (for DGS-1210-28XS/ME only)
DEM-220R	100BASE-BX, Single-mode, 20 km, Tx: 1310, Rx: 1550 nm (for DGS-1210-28XS/ME only)

Optional SFP+ Transceivers (for DGS-1210-28X/ME, 28XS/ME only)	
DEM-431XT	10GBASE-SR SFP+ Transceiver (without DDM), 33 m: OM1 MMF, 82 m: OM2 MMF, 300 m: OM3 MMF
DEM-431XT-DD	10GBASE-SR SFP+ Transceiver (with DDM), 33 m: OM1 MMF, 82 m: OM2 MMF, 300 m: OM3 MMF
DEM-432XT	10GBASE-LR SFP+ Transceiver (without DDM), 10 km
DEM-432XT-DD	10GBASE-LR SFP+ Transceiver (with DDM), 10 km
DEM-433XT	10GBASE-ER SFP+ Transceiver (without DDM), 40 km
DEM-433XT-DD	10GBASE-ER SFP+ Transceiver (with DDM), 40 km
DEM-434XT	10GBASE-ZR SFP+ Transceiver (without DDM), 80 km
DEM-436XT-BXD	10GBASE-LR BiDi SFP+ Transceiver (without DDM), Tx: 1330 nm, Rx: 1270 nm, 20 km
DEM-436XT-BXU	10GBASE-LR BiDi SFP+ Transceiver (without DDM), Tx: 1270 nm, Rx: 1330 nm, 20 km

Optional SFP+ Direct Attach Stacking Cables (for DGS-1210-28X/ME, 28XS/ME only)	
DEM-CB100S	10-Gbe SFP+ 1 m Direct Attach Cable
DEM-CB300S	10-Gbe SFP+ 3 m Direct Attach Cable
DEM-CB700S	10-Gbe SFP+ 7 m Direct Attach Cable

Appendix B – Cables and Connectors

Ethernet Cable:

When connecting the Switch to another switch, a bridge or hub, a normal cable is necessary. Please review these products for matching cable pin assignment.

The following diagrams and tables show the standard RJ-45 receptacle/connector and their pin assignments.

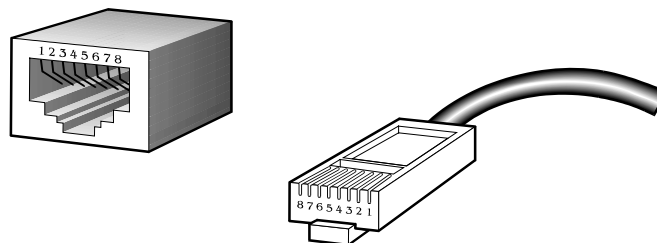

Figure D- 1. The standard RJ-45 port and connector

RJ-45 Pin Assignments		
Contact	MDI-X Port	MDI-II Port
1	RD+ (receive)	TD+ (transmit)
2	RD- (receive)	TD- (transmit)
3	TD+ (transmit)	RD+ (receive)
4	1000BASE-T	1000BASE-T
5	1000BASE-T	1000BASE-T
6	TD- (transmit)	RD- (receive)
7	1000BASE-T	1000BASE-T
8	1000BASE-T	1000BASE-T

Console Cable:

When connecting the Switch a PC, a Console cable is necessary. The following diagrams and tables show the standard Console-to-DJ-45 receptacle/connector and their pin assignments.

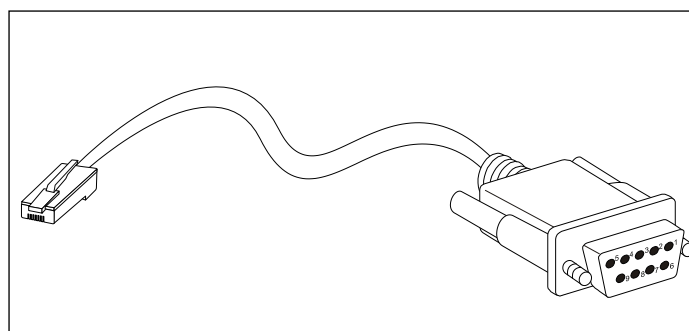

Figure B- 2. Console-to-RJ-45 Cable

Console-RJ-45 Pin Assignments		
Pin	Console (DB9/RS232)	RJ-45
1	Not Used	Not Used
2	RXD	Not Used
3	TXD	TXD

4	Not Used	GND
5	GND (shared)	GND
6	Not Used	RXD
7	Not Used	Not Used
8	Not Used	Not Used

Appendix C – Module Specs and Cable Lengths

Use the following table to as a guide for the module specs and maximum cable lengths.

Standard	Media Type	Maximum Distance
1000BASE-T	Category 5e UTP Cable	100 m
100BASE-TX	Category 5 UTP Cable (100 Mbps)	100 m
10BASE-T	Category 3, 4 or 5 UTP Cable (10 Mbps)	100 m
EIA/TIA-568	150-ohm STP	100 m
DEM-310GT	1000Base-LX, Single-mode	10k m
DEM-311GT	1000Base-SX, Multi-mode	500 m
DEM-312GT2	1000Base-SX, Multi-mode	2 km
DEM-312GT2	1000BASE-LHX, Single-mode	50 km
DEM-315GT	1000BASE-ZX, Single-mode	80 km
DGS-712	1000BASE-T Copper SFP Transceiver	100 m
DEM-302S-LX	1000BASE-LX, Single-mode	2 km
DEM-210	100BASE-FX, Single-mode (for DGS-1210-28XS/ME only)	15 km
DEM-211	100BASE-FX, Multi-mode (for DGS-1210-28XS/ME only)	2 km
DEM-330T	1000BASE-LX, TX-1550/RX-1310 nm, Single-mode	10 km
DEM-330R	1000BASE-LX, TX-1310/RX-1550 nm, Single-mode	10 km
DEM-331T	1000BASE-LX, TX-1550/RX-1310 nm, Single-Mode	40 km
DEM-331R	1000BASE-LX, TX-1310/RX-1550 nm, Single-Mode	40 km
DEM-302S-BXD	1000BASE-LX, TX-1550/Rx-1310 nm, Single-mode	2 km
DEM-302S-BXU	1000BASE-LX, TX-1310/RX-1550 nm, Single-mode	2 km
DEM-220T	100BASE-BX, TX-1550/RX-1310 nm, Single-mode (for DGS-1210-28XS/ME only)	20 km
DEM-220R	100BASE-BX, TX-1310/RX-1550 nm, Single-mode (for DGS-1210-28XS/ME only)	20 km
DEM-431XT	10GBASE-SR (without DDM), 33 m: OM1 MMF, 82 m: OM2 MMF, 300 m: OM3 MMF (for DGS-1210-28XS/ME only)	
DEM-431XT-DD	10GBASE-SR (with DDM), 33 m: OM1 MMF, 82 m: OM2 MMF, 300 m: OM3 MMF (for DGS-1210-28XS/ME only)	
DEM-432XT	10GBASE-LR (without DDM), (for DGS-1210-28XS/ME only)	10 km
DEM-432XT-DD	10GBASE-LR (with DDM), (for DGS-1210-28XS/ME only)	10 km
DEM-433XT	10GBASE-ER (without DDM) (for DGS-1210-28XS/ME only)	40 km
DEM-433XT-DD	10GBASE-ER (with DDM) (for DGS-1210-28XS/ME only)	40 km

DEM-434XT	10GBASE-ZR (without DDM) (for DGS-1210-28XS/ME only)	80 km
DEM-436XT-BXD	10GBASE-LR BiDi (without DDM), TX-1330/RX-1270 nm (for DGS-1210-28XS/ME only)	20 km
DEM-436XT-BXU	10GBASE-LR BiDi (without DDM), TX-1270/Rx-1330 nm (for DGS-1210-28XS/ME only)	20 km
DEM-CB100S	10-Gbe SFP+ 1m Direct Attach Cable	
DEM-CB300S	10-Gbe SFP+ 3m Direct Attach Cable	
DEM-CB700S	10-Gbe SFP+ 7m Direct Attach Cable	

Network pluggable optical modules meet the following regulatory requirements:

- Class 1 Laser Product
- EN60825-1+A2:2001 or later, European laser standard
- FCC 21 CFR Chapter 1, Subchapter J in accordance with FDA & CDRH requirements

Europe customers

TECHNICAL SUPPORT	dlink.com/support
TECHNISCHE UNTERSTÜTZUNG	
ASSISTANCE TECHNIQUE	
ASISTENCIA TÉCNICA	
SUPPORTO TECNICO	
TECHNISCHE ONDERSTEUNING	
POMOC TECHNICZNA	
TECHNICKÁ PODPORA	
TECHNICKÁ PODPORA	
TECHNIKAI TÁMOGATÁS	
TEKNISK SUPPORT	
TEKNISK SUPPORT	
TEKNISK STØTTE	
TEKNINEN TUKI	
ASSISTÊNCIA TÉCNICA	
ΤΕΧΝΙΚΗ ΥΠΟΣΤΗΡΙΞΗ	
TEHNIČKA PODRŠKA	
TEHNIČNA PODPORA	
SUPPORT TEHNIC	
ТЕХНИЧЕСКА ПОДДРЪЖКА	

Australia customers

Tel: 1300-700-100

24/7 Technical Support

Web: <http://www.dlink.com.au>

E-mail: support@dlink.com.au

India customers

Tel: +91-832-2856000

Toll Free 1800-233-0000 Web:

www.dlink.co.in

E-Mail: helpdesk@in.dlink.com

Singapore, Thailand, Indonesia, Malaysia, Philippines,

Vietnam customers

Singapore - www.dlink.com.sg

Thailand - www.dlink.co.th

Indonesia - www.dlink.co.id

Malaysia - www.dlink.com.my

Philippines - www.dlink.com.ph

Vietnam - www.dlink.com.vn

Korea customers

Tel : +82-2-2028-1810

Monday to Friday 9:00am to 6:00pm

Web : <http://d-link.co.kr>

E-mail : g2b@d-link.co.kr

New Zealand customers

Tel: 0800-900-900

24/7 Technical Support

Web: <http://www.dlink.co.nz>

E-mail: support@dlink.co.nz

South Africa and Sub Sahara Region customers

Tel: +27 12 661 2025

08600 DLINK (for South Africa only)

Monday to Friday 8:30am to 9:00pm South Africa Time

Web: <http://www.d-link.co.za>

E-mail: support@d-link.co.za

D-Link Middle East - Dubai, U.A.E. customers

Plot No. S31102,

Jebel Ali Free Zone South,

P.O.Box 18224, Dubai, U.A.E.

Tel: +971-4-8809022

Fax: +971-4-8809066 / 8809069

Technical Support: +971-4-8809033

General Inquiries: info.me@dlinkmea.com

Tech Support: support.me@dlinkmea.com

Egypt customers

1, Makram Ebeid Street -

City Light Building - floor 5

Nasrcity - Cairo, Egypt

Tel.: +2 02 23521593 - +2 02 23520852

Technical Support: +2 02 26738470

General Inquiries: info.eg@dlinkmea.com

Tech Support: support.eg@dlinkmea.com

Kingdom of Saudi Arabia customers

Office # 84 ,

Al Khaleej Building (Mujamathu Al-Khaleej)

Opp. King Fahd Road, Olaya

Riyadh - Saudi Arabia

Tel: +966 1121 70008

Technical Support:

+966 1121 70009

General Inquiries: info.sa@dlinkmea.com

Tech Support: support.sa@dlinkmea.com

Pakistan customers

Islamabad Office:

61-A, Jinnah Avenue, Blue Area,
Suite # 11, EBC, Saudi Pak Tower,
Islamabad - Pakistan

Tel.: +92-51-2800397, 2800398

Fax: +92-51-2800399

Karachi Office:

D-147/1, KDA Scheme # 1,
Opposite Mudassir Park, Karsaz Road,
Karachi – Pakistan

Phone: +92-21-34548158, 34326649

Fax: +92-21-4375727

Technical Support: +92-21-34548310, 34305069

General Inquiries: info.pk@dlinkmea.com

Tech Support: support.pk@dlinkmea.com

Iran customers

Unit 5, 5th Floor, No. 20, 17th Alley , Bokharest St. , Argentine Sq. ,
Tehran IRAN

Postal Code : 1513833817

Tel: +98-21-88880918,19

+98-21-88706653,54

General Inquiries: info.ir@dlinkmea.com

Tech Support: support.ir@dlinkmea.com

Morocco customers

M.I.T.C

Route de Nouaceur angle RS et CT 1029 Bureau N° 312 ET 337

Casablanca , Maroc

Phone : +212 663 72 73 24

Email: support.na@dlinkmea.com

Lebanon RMA center customers

Dbayeh/Lebanon

PO Box:901589

Tel: +961 4 54 49 71 Ext:14

Fax: +961 4 54 49 71 Ext:12

Email: taoun@dlinkmea.com

Bahrain customers

Technical Support: +973 1 3332904

Kuwait customers

Technical Support: + 965 22453939 / +965 22453949

Türkiye customers

Büyükdere Cad. Ferro Plaza No:155

D: 1 K: 1 Zincirlikuyu / Istanbul

Tel: +90 (212) 289-56-59

Email: info.tr@dlink.com.tr

לארשי

רטנס וולטמ

20 מימישגמה 'חר

7060 ד"ת, 49348 ת"פ, וולטמ תירק

לט: 03-9215173

לט: 073-7962797

יילכ ל"אוד: info@dlink.co.il

הכימת ל"אוד: support@dlink.co.il

Техническая Поддержка

Обновления программного обеспечения и документация доступны на Интернет-сайте D-Link. D-Link предоставляет бесплатную поддержку для клиентов в течение гарантийного срока. Клиенты могут обратиться в группу технической поддержки D-Link по телефону или через Интернет.

Техническая поддержка компании D-Link работает в круглосуточном режиме ежедневно, кроме официальных праздничных дней. Звонок бесплатный по всей России.

Техническая поддержка D-Link:
8-800-700-5465

Техническая поддержка через Интернет:
<http://www.dlink.ru>
e-mail: support@dlink.ru

Офисы

Россия

Москва, Графский переулок, 14

Тел. : +7 (495) 744-00-99

E-mail: mail@dlink.ru

Україна

Київ, вул. Межигірська, 87-А

Тел.: +38 (044) 545-64-40

E-mail: ua@dlink.ua

Moldova

Chisinau; str.C.Negruzzi-8

Tel:+373(22) 80-81-07

E-mail:info@dlink.md

Беларусь

Мінск, пр-т Незалежнасці, 169

Тэл.: +375 (17) 218-13-65

E-mail: support@dlink.by

Қазақстан

Алматы, қ. Құрманғазы, 143 үй

Тел.: +7 (727) 378-55-90

E-mail: almaty@dlink.ru

Հայաստան

Երևան, Դավթաշեն 3-րդ

թաղամաս, 23/5

Հեռ.՝ +374 (10) 39-86-67

Էլ. փոստ՝ info@dlink.am

საქართველო

თბილისი, მარიჯანის ქუჩა N4

ტელ.: +995 (032) 220-77-01

E-mail: info@dlink.ge

Latvija

Rīga, Lielirbes iela 27

Tel.: +371 (6) 761-87-03

E-mail: info@dlink.lv

Lietuva

Vilnius, Žirmūnų 139-303

Tel.: +370 (5) 236-36-29

E-mail: info@dlink.lt

Eesti

E-mail: info@dlink.ee

Soporte Técnico Para Usuarios En Latino America

Por favor revise el número telefónico del Call Center de su país en <http://www.dlinkla.com/soporte/call-center>

Soporte Técnico de D-Link a través de Internet

Horario de atención Soporte Técnico en www.dlinkla.com

e-mail: soporte@dlinkla.com & consultas@dlinkla.com

Clientes de Brasil

Caso tenha dúvidas na instalação do produto, entre em contato com o Suporte Técnico D-Link.

Acesse o site: **www.dlink.com.br/suporte**

D-Link 友訊科技 台灣分公司 技術支援資訊

如果您還有任何本使用手冊無法協助您解決的產品相關問題，台灣地區用戶可以透過我們的網站、電子郵件或電話等方式與D-Link台灣地區技術支援工程師聯絡。

D-Link 免付費技術諮詢專線

0800-002-615

手機付費電話 (02)6600-0123#8715

服務時間：週一至週五，早上9:00到晚上9:00

週六日及國定假日(不含農曆春節) 早上10:00到晚上7:00

網 站：<http://www.dlink.com.tw>

電子郵件：dssqa_service@dlink.com.tw

如果您是台灣地區以外的用戶，請參考D-Link網站，全球各地分公司的聯絡資訊以取得相關支援服務。

產品保固期限、台灣區維修據點查詢，請參考以下網頁說明：

<http://www.dlink.com.tw>

產品維修：

使用者可直接送至全省聯強直營維修站或請洽您的原購買經銷商。

Pelanggan Indonesia

Update perangkat lunak dan dokumentasi pengguna dapat diperoleh pada situs web D-Link.

Dukungan Teknis untuk pelanggan:

Tel: +62-21-5731610

Dukungan Teknis D-Link melalui Internet:

Email : support@dlink.co.id

Website : <http://support.dlink.co.id>

日本のお客様

この度は弊社製品をお買い上げいただき、誠にありがとうございます。

製品に同梱されている保証書の購入元にお問い合わせください。

中国客户

技术支持中心电话：400-629-6688

技术支持中心邮箱：dlink400@cn.dlink.com

各地维修中心地址请登录官方网站查询

网址：<http://www.dlink.com.cn>

400电话工作时间：工作日9:00-19:00；节假日9:00-18:00

Registration Card

All Countries and Regions Excluding USA

Print, type or use block letters.

Your name: Mr./Ms _____

Organization: _____ Dept. _____

Your title at organization: _____

Telephone: _____ Fax: _____

Organization's full address: _____

Country: _____

Date of purchase (Month/Day/Year): _____

Product Model	Product Serial No.	* Product installed in type of computer	* Product installed in computer serial No.

(* Applies to adapters only)

Product was purchased from:

Reseller's name: _____

Telephone: _____

Answers to the following questions help us to support your product:

1. Where and how will the product primarily be used?

Home Office Travel Company Business Home Business Personal Use

2. How many employees work at installation site?

1 employee 2-9 10-49 50-99 100-499 500-999 1000 or more

3. What network protocol(s) does your organization use ?

XNS/IPX TCP/IP DECnet Others _____

4. What network operating system(s) does your organization use ?

D-Link LANsmart Novell NetWare NetWare Lite SCO Unix/Xenix PC NFS 3Com 3+Open Cisco Network
Banyan Vines DECnet Pathwork Windows NT Windows 98 Windows 2000/ME Windows XP
Others _____

5. What network management program does your organization use ?

D-View HP OpenView/Windows HP OpenView/Unix SunNet Manager Novell NMS
NetView 6000 Others _____

6. What network medium/media does your organization use ?

Fiber-optics Thick coax Ethernet Thin coax Ethernet 10BASE-T UTP/STP
100BASE-TX 1000BASE-T Wireless 802.11b and 802.11g wireless 802.11a Others _____

7. What applications are used on your network?

Desktop publishing Spreadsheet Word processing CAD/CAM
Database management Accounting Others _____

8. What category best describes your company?

Aerospace Engineering Education Finance Hospital Legal Insurance/Real Estate Manufacturing
Retail/Chain store/Wholesale Government Transportation/Utilities/Communication VAR
System house/company Other _____

9. Would you recommend your D-Link product to a friend?

Yes No Don't know yet

10. Your comments on this product?

PLEASE
PLACE STAMP
HERE

TO:

D-Link®

