



U401A Series LED Monitor

User's Manual



Foreword

General





This manual introduces the installation, functions and operations of the U401A series display equipment (hereinafter referred to as "the Device"). Read carefully before using the device, and keep the manual safe for future reference.

Models

This manual applies to Dahua U401A Series monitor models. For example: DHI-LM27-U401A.

Safety Instructions

The following signal words might appear in the manual.

Signal Words	Meaning
 DANGER	Indicates a high potential hazard which, if not avoided, will result in death or serious injury.
 WARNING	Indicates a medium or low potential hazard which, if not avoided, could result in slight or moderate injury.
 CAUTION	Indicates a potential risk which, if not avoided, could result in property damage, data loss, reductions in performance, or unpredictable results.
 TIPS	Provides methods to help you solve a problem or save time.
 NOTE	Provides additional information as a supplement to the text.

Privacy Protection Notice

As the device user or data controller, you might collect the personal data of others such as their face, audio, fingerprints, and license plate number. You need to be in compliance with your local privacy protection laws and regulations to protect the legitimate rights and interests of other people by implementing measures which include but are not limited: Providing clear and visible identification to inform people of the existence of the surveillance area and provide required contact information.

About the Manual

The manual is for reference only. Slight differences might be found between the manual and the product.

- We are not liable for losses incurred due to operating the product in ways that are not in compliance with the manual.
- The manual will be updated according to the latest laws and regulations of related jurisdictions. For detailed information, see the paper user's manual, use our CD-ROM, scan the QR code or visit our official website. The manual is for reference only. Slight differences might be found between the electronic version and the paper version.
- All designs and software are subject to change without prior written notice. Product updates might result in some differences appearing between the actual product and the manual. Please contact customer service for the latest program and supplementary documentation.
- There might be errors in the print or deviations in the description of the functions, operations and technical data. If there is any doubt or dispute, we reserve the right of final explanation.
- Upgrade the reader software or try other mainstream reader software if the manual (in PDF format) cannot be opened.
- All trademarks, registered trademarks and company names in the manual are properties of their respective owners.
- Please visit our website, contact the supplier or customer service if any problems occur while using the device.
- If there is any uncertainty or controversy, we reserve the right of final explanation.

Important Safeguards and Warnings

This section introduces content covering the proper handling of the device, hazard prevention, and prevention of property damage. Read carefully before using the device, and comply with the guidelines when using it.

Operation Requirements



WARNING

- Do not tread on or squeeze the power line, especially the plug or connection point of the power line to the product.
- Please firmly grasp the plug of the connecting line when inserting and removing. Pulling the connecting line might cause damage to it.
- Turn off the power when cleaning the product.
- Do not touch any fixed components inside the product. Failure to do so can result in damage to the product or person.



- Make sure that the power supply of the device works properly before use.
- Do not pull out the power cable of the device while it is powered on.
- Only use the device within the rated power range.
- Transport, use and store the device under allowed humidity and temperature conditions.
- Prevent liquids from splashing or dripping on the device. Make sure that there are no objects filled with liquid on top of the device to avoid liquids flowing into it.
- Do not disassemble the device.
- Notice and observe all the warnings and illustrations.
- Make sure the power is turned off and the connecting lines are removed when moving the product. Do not use uncertified connecting lines, which might cause equipment failure.
- Avoid collisions with the product. This may cause equipment failure.
- Please turn off power for safety if not using the product for a long time.

Installation Requirements



WARNING

- Connect the device to the adapter before power on.
- Strictly abide by local electrical safety standards, and make sure that the voltage in the area is steady and conforms to the power requirements of the device.
- Do not connect the device to more than one power supply. Otherwise, the device might become damaged.
- Do not hang or lean on the product. Doing so can cause the product to fall or become damaged. It may also cause injury to people. Pay special attention when children are nearby.

- If the product is installed on the wall, please make sure the wall's load bearing capacity is sufficient. To avoid falling and injuring people, install according to the included instructions with mounting hardware.
- Do not put the product in flammable or corrosive gaseous environment, which may cause fire or damage the product. Placing the product in proximity to flammable gas can easily result in a dangerous explosion.



- Observe all safety procedures and wear required protective equipment provided for your use while working at heights.
- Do not expose the device to direct sunlight or heat sources.
- Do not install the device in humid, dusty or smoky places.
- Install the device in a well-ventilated place, and do not block the ventilator of the device.
- Use the power adapter or case power supply provided by the device manufacturer.
- The power supply must conform to the requirements of ES1 in IEC 62368-1 standard and be no higher than PS2. Note that the power supply requirements are subject to the device label.
- Connect class I electrical appliances to a power socket with protective earthing.
- Do not block the ventilation opening. Install the product according to this handbook.
- Do not place any items on the product. The product may be damaged if foreign objects enter the internal unit.
- Failure to properly secure all screws during installation can result in a fall of the product. Ensure all mounting hardware and other installation accessories are properly secured during installation.
- Mounted height: < 2m.
-  Protective earthing terminal. The apparatus should be connected to a mains socket outlet with a protective earthing connection.
- ~ Alternating Current.

Maintenance Requirements



WARNING

- Cut off power and the connecting line immediately and contact the after-sales service center if the product or the connecting line is damaged for some reason. Continued use without maintenance might cause smoking or off-odor.
- Please turn off power or unplug the power cable immediately if there is smoking, off-odor, or abnormal noise. Contact the after-sales service center for maintenance after confirming there is no more smoke or odor. Further use could result in fire.



- Do not adjust, maintain or modify if you do not have appropriate qualifications.
- Do not open or remove the rear cover, box or cover board of the product. Please contact the dealer or after-sales service center when in need of adjustment or maintenance.

- Only qualified service people can maintain. If the product gets any kind of damage, such as damage to the plug, foreign matter or liquid into the unit, exposure to rain or humidity, loss of function, or dropped, please contact dealer or after-sales service center.
- Be careful during maintenance of product even if the power is off. Some components are equipped with UPS, and can continue to supply power which is dangerous to people.

HDMI™
HIGH-DEFINITION MULTIMEDIA INTERFACE

The terms HDMI, HDMI High-Definition Multimedia Interface, HDMI Trade dress and the HDMI Logos are trademarks or registered trademarks of HDMI Licensing Administrator, Inc.

Table of Contents

Foreword.....	I
Important Safeguards and Warnings.....	III
1 Packing List.....	1
2 Angle Adjustment	2
3 Button Description	3
4 Cable Connection	4
5 Menu Description	5
6 ECO Modes	7
7 Operation Menu (OSD) Function Descriptions.....	8
8 Product Specifications.....	10
Appendix 1 Troubleshooting.....	11
Appendix 2 Cybersecurity Recommendations	12

1 Packing List

Figure 1-1 Packing list

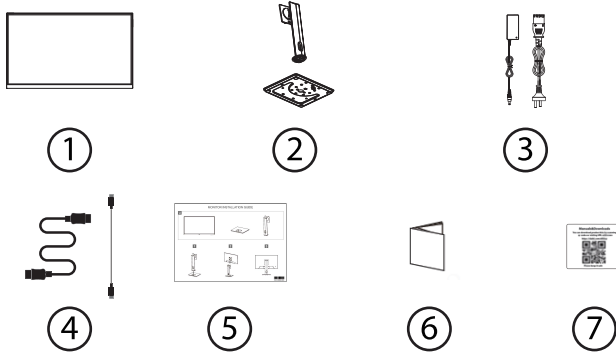

Table 1-1 Packing list

No.	Name
1	Display screen
2	Base/Stand
3	Power adapter
4	Signal cable
5	Installation guide
6	Legal and regulatory information
7	User's manual QR code stickers

NOTE

The above images are for reference only. Please refer to the actual device for detailed information.

2 Monitor Adjustments

The screen can be adjusted by inclining forward and backward; however, the specific adjustment depends on the specific model of the device. Generally, it may be inclined $3\pm 2^\circ$ forward and $21\pm 2^\circ$ backward.

Figure 2-1 Monitor Adjustments

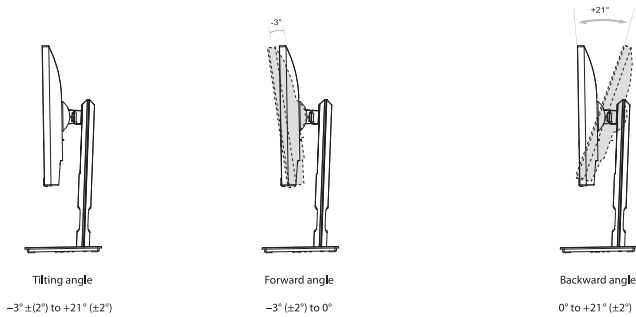

NOTE

- When adjusting the angle of the monitor, be sure not to touch or press the area of the screen.
- The above images are for reference only. Please refer to the actual device for detailed information.

Figure 2-2 Monitor Adjustments

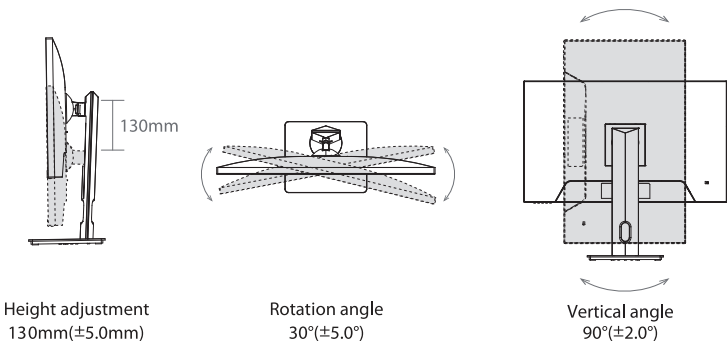

NOTE

- When adjusting the angle of the monitor, be sure not to touch or press the area of the screen.
- The above images are for reference only. Please refer to the actual device for detailed information.

3 Button Description

Figure 3-1 Button adjustment

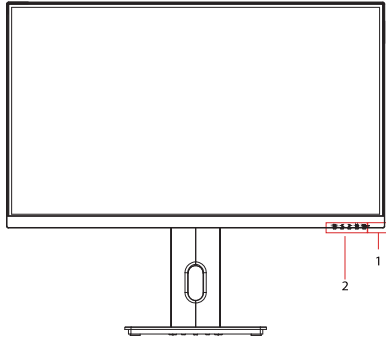





Table 3-1 Button description

No.	Name	Description
1	LED indicator light	<ul style="list-style-type: none"> ● The light is green when the screen is turned on. ● The light is orange when the screen enters energy saving mode. ● The light is off when the screen is turned off.
2	OSD/Power button	Press the button to turn on the monitor.

Table 3-2 OSD Buttons

OSD Button	Function
	Shows main choice menus
<	Adjust the options-move up or lower/Hot key(option)
>	Adjust the options-move down or higher/Hot key(option)
	Exit main menu, or when no menus-Signal switching
	Power ON/OFF button

4 Cable Connection

Figure 4-1 Input and output ports

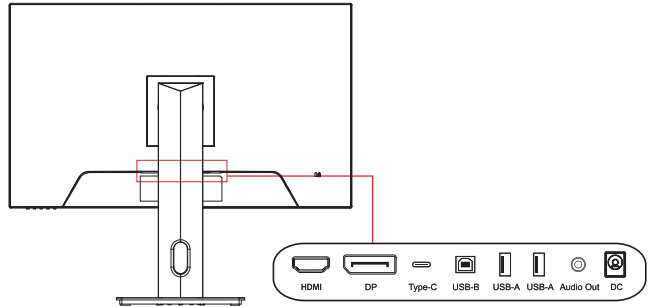

NOTE

The above ports are for explanation only, and the specific ports are subject to the actual display.

HDMI interface	Type-C interface
<p>Use the HDMI cable to connect the HDMI IN interface of the product to the HDMI OUT interface of a PC.</p>	<p>Use a Type-C cable to connect the Type-C interface of the product to the Type-C interface of the PC.(You can also choose other cable, such as USB-B/USB-A/DP cable, for data transmission.)</p>
AUDIO OUT	Power Adapter
<p>Connect audio outputting devices such as earphones to the Audio out interface.</p>	<p>Please connect the power adapter plug to the corresponding power port of the monitor, and connect the other end to a properly grounded power outlet.</p>

5 Menu Description





- The color and shape of the OSD menu of the actual computer may be slightly different from them shown in the figure.
 - Specifications of the OSD menu may change with improvements of functions without prior notice.
- The on-screen display (OSD) menu can be used to adjust the settings of the monitor and is displayed on the screen after turning on the monitor and pressing the  button.

Step 1 Press one of the buttons to activate the browser screen.

Figure 5-1 Browser screen



Table 5-1 Browser screen description

Icon	Function
	Menu/Enter
	Up
	Down
	Auto/Exit
	Power ON/OFF









Step 2 Press  to enter the OSD screen.

Figure 5-2 OSD screen



Step 3 Press  or  to browse through the functions.

- Select the desired function, then press the  button to enter the submenu.
- Press  or  to browse the sub-menus, and then press  to confirm the selection of the desired function.

- Press < or > to select an option, then press  to confirm the setting and exit the current menu.

Step 4 Press  to exit the menu interface.

6 ECO Modes



Step 1 Press any one of the buttons ( , < , > ,  , ) to activate the navigation window.

Figure 6-1 Navigation window



Step 2 Press  to switch ECO modes. These modes (Standard, Photo, Movie, Game, FPS, RTS) can be used to optimize settings according to your activity. Standard mode is suitable for most activities.

Figure 6-2 Standard mode

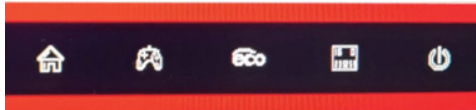

7 Operation Menu (OSD) Function Descriptions

Functions of the monitor vary with models, and the functions in this manual are for reference only.

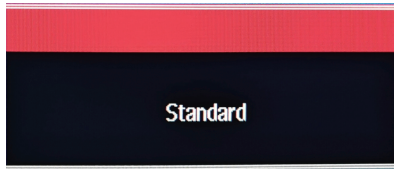
Table 7-1 Menu description

Menu	Sub Menu	Value Range
Input Source	Type-C	—
	DP	—
	HDMI	—
Brightness Contrast	Brightness	0-100
	Blacklevel	0-100
	Contrast	0-100
	DCR	ON OFF
Color Setting	Gamma	2.2
		2.4
	Picture Mode	Standard
		Photo
		Movie
		Game
		FPS
	Color Temperature	RTS
		Normal
		Warm
		Cool
sRGB		
USER		
Low Blue Light	0-100	
Picture Quality Setting	Sharpness	0-100
	Response Time	Off
		Low
		Middle
High		
Display	Aspect Ratio	Wide Screen
		4:3

Audio	Volume	0-100
Multi-Window	Multi-Window	off
		PIP Mode
		PBP 2Win
	Sub Win2 Input	Type-C/DP/HDMI
	PIP Size	Small
		Medium
		Large
	PIP Position	Top Right
Top Left		
Bottom Right		
Bottom Left		
Swap	—	
OSD	Language	10 Languages
	OSD H- Position	0-100
	OSD V- Position	0-100
	OSD Transparency	0-100
	OSD Time Out	5-60
	OSD Rotation	Normal/90/180/270
Other	Adaptive-Sync	On/Off
	HDR	Off/On/Auto Detect
	USB Power Control	Off/On
	USB HUB Select	USB-B/USB-C
	Gravity Induction	Off/On
	Reset	—

8 Product Specifications

Product model		DHI-LM27-U401A
Screen Size		27"
Aspect Ratio		16:9
Viewing Angle		178°(H) / 178°(V)
Contrast ratio		1000:1(Typ.)
Colors		1.07B
Resolution		3840x2160
Maximum refresh rate		60Hz
Product Dimensions	Without base	613.7 x 366.7 x 52.7 mm
	With base	613.7 x 540.7x 200 mm
speaker		N/A
Height range		130 ±5mm
Rotation angle		left:-30°±5°, right: 30°±5°
Vertical angle		left:-90°±2°, right: 90°±2°
Tilting angle		Forward tilting: 3° ± 2°; Backward tilting: 21° ± 2°
Environmental conditions	Action	Temperature: 0°C~ 40°C (32°F ~ 104°F) Humidity: 10%~90% RH (non-condensing)
	Storage	Temperature: -20°C ~ 60°C (-4°F ~ 140°F) Humidity: 5%~90% RH (non-condensing)

NOTE

The actual application of the above parameters shall be subject to the specific model.

Appendix 1 Troubleshooting

Appendix Table 1-1 FAQ

Faults Occurring	Possible Solutions
The power indicator light is not on	<ul style="list-style-type: none"> ● Check if the power is on. ● Check if the power cord is connected.
Plug and play failed	<ul style="list-style-type: none"> ● Check if the function of plug-and-play of the device is compatible with PC. ● Check if the display card is compatible with the plug-and-play function.
Dimming picture	Adjust brightness and contrast.
Flickering picture or picture with ripples	There may be electrical appliances or equipment with electronic disturbance.
The power indicator light is on (flickering), but the monitor has no pictures.	<ul style="list-style-type: none"> ● Check if the PC power is on. ● Check if the PC display card is inserted properly. ● Check if the signal cable of the monitor is correctly connected with the PC. ● Check the signal cable plug of the monitor and make sure every pin has no bending. ● Observe the indicator light by pressing the Caps Lock key on the PC keyboard and check if the PC is working.
Color shortage (red, green and blue)	Check the signal cable of the monitor and make sure every pin has no bending.
The picture is not in the middle, or the size is not right	Hot key(AUTO)
Picture with color difference (white looks not white)	Adjust RGB color or reselect color temperature.
Screen font blur under VGA/HDMI signal	Select M to automatically adjust the image.

Appendix 2 Cybersecurity Recommendations

Cybersecurity is more than just a buzzword: it's something that pertains to every device that is connected to the internet. IP video surveillance is not immune to cyber risks, but taking basic steps toward protecting and strengthening networks and networked appliances will make them less susceptible to attacks. Below are some tips and recommendations from Dahua on how to create a more secured security system.

Mandatory actions to be taken for basic device network security:

1. Use Strong Passwords

Please refer to the following suggestions to set passwords.

- The length should not be less than 8 characters.
- Include at least two types of characters; character types include upper and lower case letters, numbers and symbols.
- Do not contain the account name or the account name in reverse order.
- Do not use continuous characters, such as 123, abc, etc.
- Do not use overlapped characters, such as 111, aaa, etc.

2. Update Firmware and Client Software in Time

- According to the standard procedure in Tech-industry, we recommend to keep your device (such as NVR, DVR, IP camera, etc.) firmware up-to-date to ensure the system is equipped with the latest security patches and fixes. When the device is connected to the public network, it is recommended to enable the "auto-check for updates" function to obtain timely information of firmware updates released by the manufacturer.
- We suggest that you download and use the latest version of client software.

"Nice to have" recommendations to improve your device network security:

1. Physical Protection

We suggest that you perform physical protection to device, especially storage devices. For example, place the device in a special computer room and cabinet, and implement well-done access control permission and key management to prevent unauthorized personnel from carrying out physical contacts such as damaging hardware, unauthorized connection of removable device (such as USB flash disk, serial port), etc.

2. Change Passwords Regularly

We suggest that you change passwords regularly to reduce the risk of being guessed or cracked.

3. Set and Update Passwords Reset Information Timely

The device supports password reset function. Please set up related information for password reset in time, including the end user's mailbox and password protection questions. If the information changes, please modify it in time. When setting password protection questions, it is suggested not to use those that can be easily guessed.

4. Enable Account Lock

The account lock feature is enabled by default, and we recommend you to keep it on to guarantee the account security. If an attacker attempts to log in with the wrong password several times, the corresponding account and the source IP address will be locked.

5. Change Default HTTP and Other Service Ports

We suggest you to change default HTTP and other service ports into any set of numbers between

1024–65535, reducing the risk of outsiders being able to guess which ports you are using.

6. Enable HTTPS

We suggest you to enable HTTPS, so that you visit Web service through a secure communication channel.

7. MAC Address Binding

We recommend you to bind the IP and MAC address of the gateway to the device, thus reducing the risk of ARP spoofing.

8. Assign Accounts and Privileges Reasonably

According to business and management requirements, reasonably add users and assign a minimum set of permissions to them.

9. Disable Unnecessary Services and Choose Secure Modes

If not needed, it is recommended to turn off some services such as SNMP, SMTP, UPnP, etc., to reduce risks.

If necessary, it is highly recommended that you use safe modes, including but not limited to the following services:

- SNMP: Choose SNMP v3, and set up strong encryption passwords and authentication passwords.
- SMTP: Choose TLS to access mailbox server.
- FTP: Choose SFTP, and set up strong passwords.
- AP hotspot: Choose WPA2-PSK encryption mode, and set up strong passwords.

10. Audio and Video Encrypted Transmission

If your audio and video data contents are very important or sensitive, we recommend that you use encrypted transmission function, to reduce the risk of audio and video data being stolen during transmission.

Reminder: encrypted transmission will cause some loss in transmission efficiency.

11. Secure Auditing

- Check online users: we suggest that you check online users regularly to see if the device is logged in without authorization.
- Check device log: By viewing the logs, you can know the IP addresses that were used to log in to your devices and their key operations.

12. Network Log

Due to the limited storage capacity of the device, the stored log is limited. If you need to save the log for a long time, it is recommended that you enable the network log function to ensure that the critical logs are synchronized to the network log server for tracing.

13. Construct a Safe Network Environment

In order to better ensure the safety of device and reduce potential cyber risks, we recommend:

- Disable the port mapping function of the router to avoid direct access to the intranet devices from external network.
- The network should be partitioned and isolated according to the actual network needs. If there are no communication requirements between two sub networks, it is suggested to use VLAN, network GAP and other technologies to partition the network, so as to achieve the network isolation effect.
- Establish the 802.1x access authentication system to reduce the risk of unauthorized access to private networks.

- Enable IP/MAC address filtering function to limit the range of hosts allowed to access the device.

More information

Please visit Dahua official website security emergency response center for security announcements and the latest security recommendations.

ENABLING A SAFER SOCIETY AND SMARTER LIVING