

NGDP

PC POWER SUPPLY

GOLD FULL-MODULAR



Edited by Amanda
Version 1.1
2023.12.06

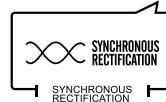
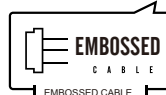
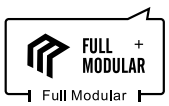
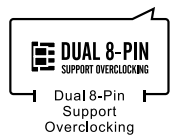
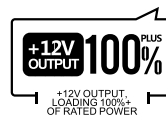
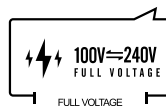
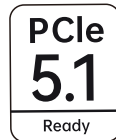
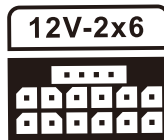



MODEL : HA-750BA4

Dimensions(L*W*H)	140*150*86MM
Modular	Full-Modular
Certifications	80 PLUS GOLD
Warranty	10 years
Efficiency	90.21%At Full Load (Date From 80 PLUS Verification And Testing Report)
PFC	Active PFC
FanSize	120MM FDB
Protections	UVP,OVP,OPP, SCP, OCP,OTP
Operation Temperature	0~40°C
Circuit Structure	LLC+DC-DC



MODEL : HA-850BA4

Dimensions(L*W*H)	140*150*86MM
Modular	Full-Modular
Certifications	80 PLUS GOLD
Warranty	10 years
Efficiency	90.48% At Full Load (Date From 80 PLUS Verification And Testing Report)
PFC	Active PFC
FanSize	120MM FDB
Protections	UVP,OVP,OPP, SCP, OCP,OTP
Operation Temperature	0~40°C
Circuit Structure	LLC+DC-DC



MODEL : HA-1000BA4

Dimensions(L*W*H)	140*150*86MM
Modular	Full-Modular
Certifications	80 PLUS GOLD
Warranty	10 years
Efficiency	90.80%At Full Load (Date From 80 PLUS Verification And Testing Report)
PFC	Active PFC
FanSize	120MM FDB
Protections	UVP,OVP,OPP, SCP, OCP,OTP
Operation Temperature	0~40°C
Circuit Structure	LLC+DC-DC



100-240Vac
50-60Hz
10-5A

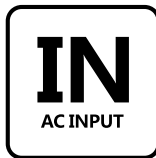

100-240Vac
50-60Hz
10-5A



100-240Vac
50-60Hz
12-6A



+5V 20A
+3.3V 20A
+12V 62.5A
+5VSB 3.0A
-12V 0.3A



+5V 20A
+3.3V 20A
+12V 70.8A
+5VSB 3.0A
-12V 0.3A



+5V 20A
+3.3V 20A
+12V 83A
+5VSB 3.0A
-12V 0.3A



+5V/+3.3V 120W
+12V 750W
RATED PWOER
750W



+5V/+3.3V 120W
+12V 849.6W
RATED PWOER
850W



+5V/+3.3V 120W
+12V 996W
RATED PWOER
1000W

Safety&Regular

EAC CB RoHS FCC CE

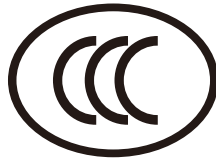

SAA-202494-EA



Scope Of Delivery

Screws*4

Jumper Wire*1

Cable Ties*4

Power Cord*1

Nylon Tie *10

MES ID Card *1

Brand Service card *1

Wiring Instructions *1

Cable Comb Organizer*14
(24PIN 5PCS/16PIN 3PCS/8PIN 3PCS/2*6PIN 3PCS)

User Manual Language:

CN.DE. EN.ES,FR. Japan. Poland. RU. RU. TW. KR

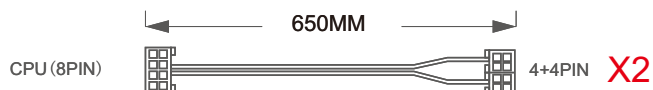
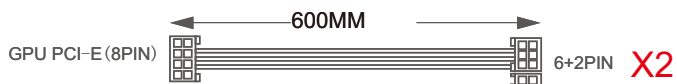
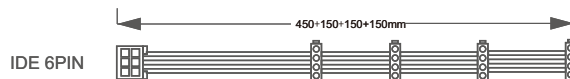
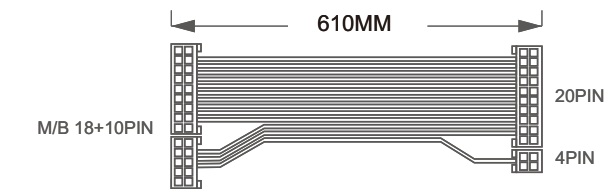

MODEL: HA-750BA4

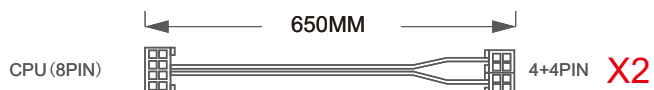
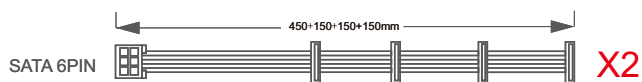
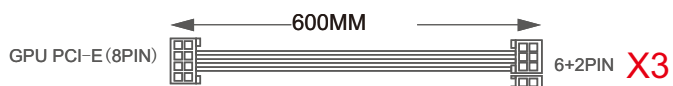
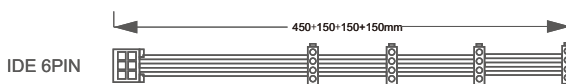
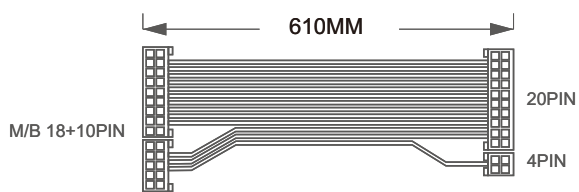

MODEL: HA-850BA4

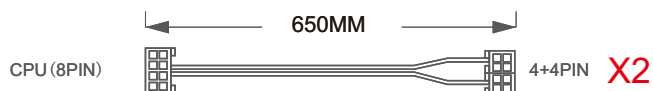
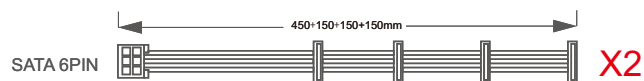
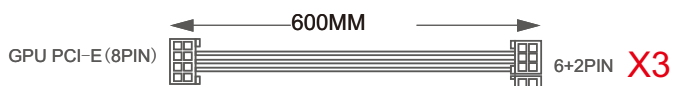
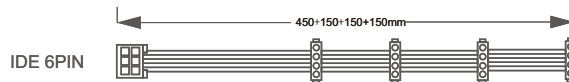
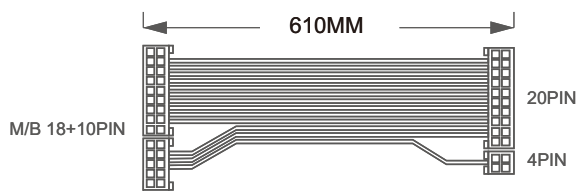

MODEL: HA-1000BA4

Pin Layout

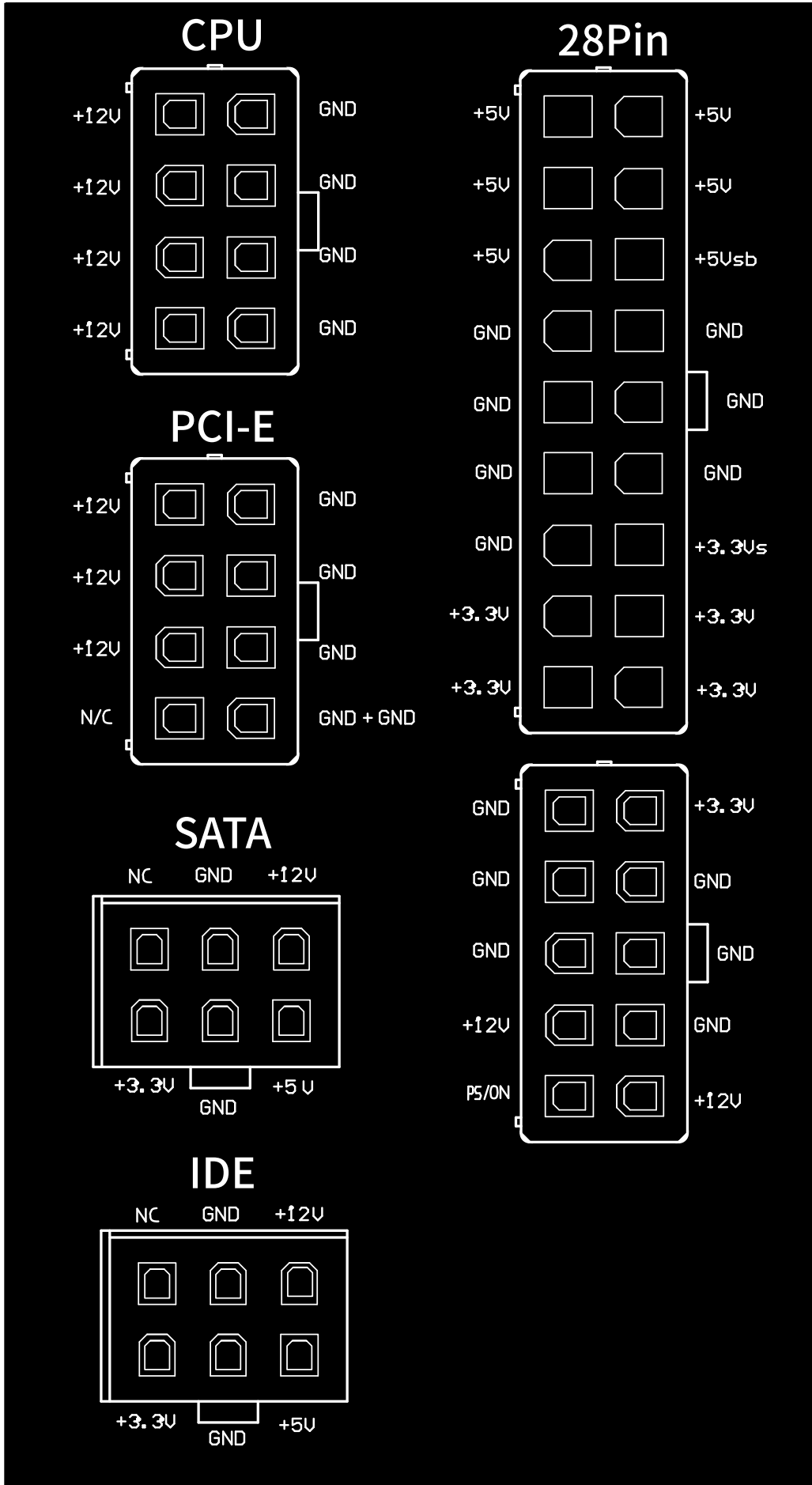

Full Modular Connector Guideline

VER: FM3

FM3

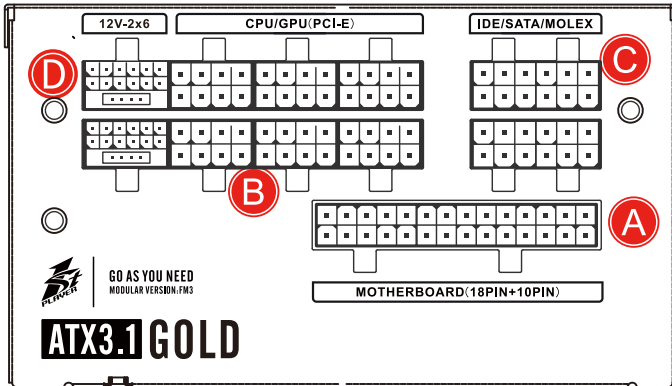

PSU modular port

PC Hardware

A / M/B 18+10PIN

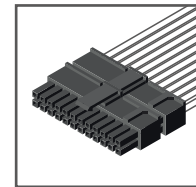
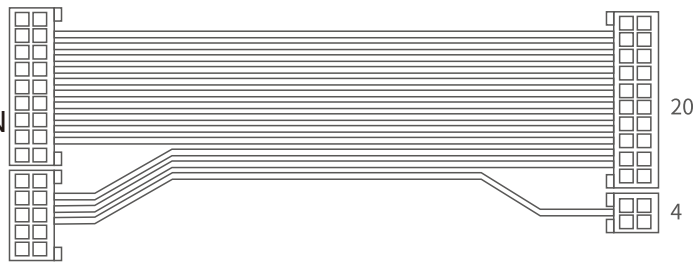

B / CPU(8PIN)

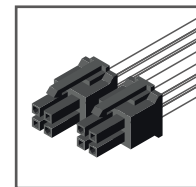

B / PCI-E(PIN)

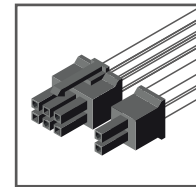

C / SATA(6PIN)

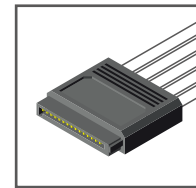
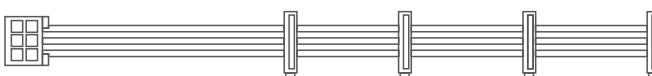

C / IDE(6PIN)

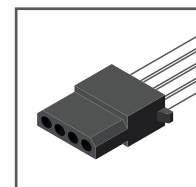
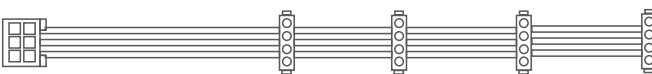

D / PCI-E 5.1(12V-2x6)

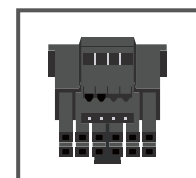

CONNECT THE WIRES ACCORDING TO THE CORRESPONDING COLOR

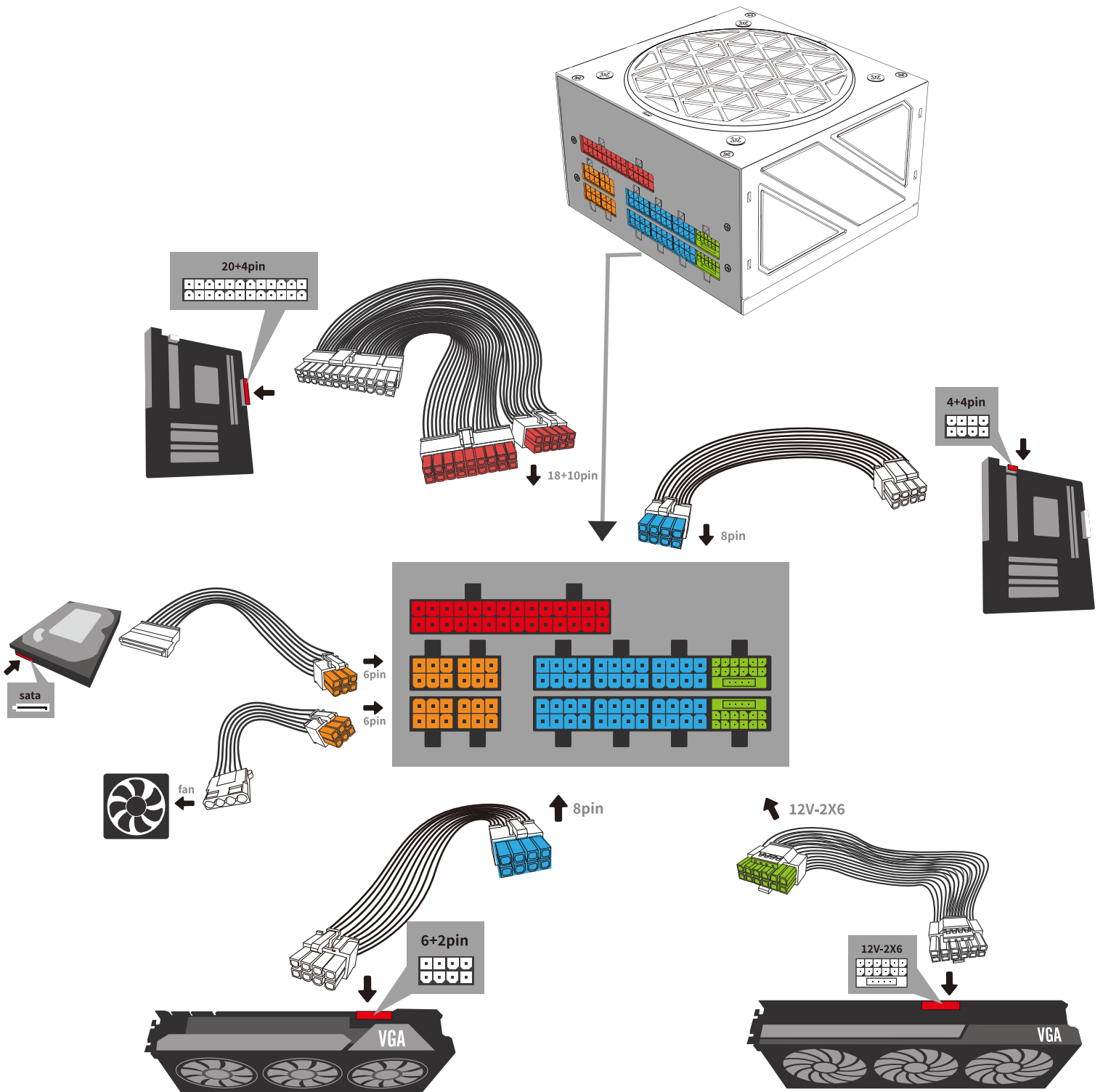

1 PC connection guide **Guideline**

- 1 Install the PSU into the PC case with cooling fan side at the bottom, then screw on.

- 2 24PIN (20+4) connector connects motherboard.

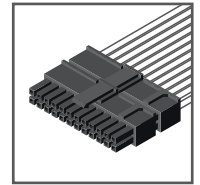

- 3 8PIN (4+4) connector connects CPU.

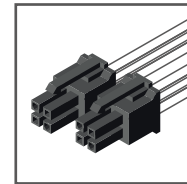

- 4 8PIN (6+2) connector connects VGA.

Note: There are multiple kinds of VGA connectors, 6PIN, 6+2PIN&6PIN, 6+2PIN&6+2PIN. Please select your PSU as your requirement.

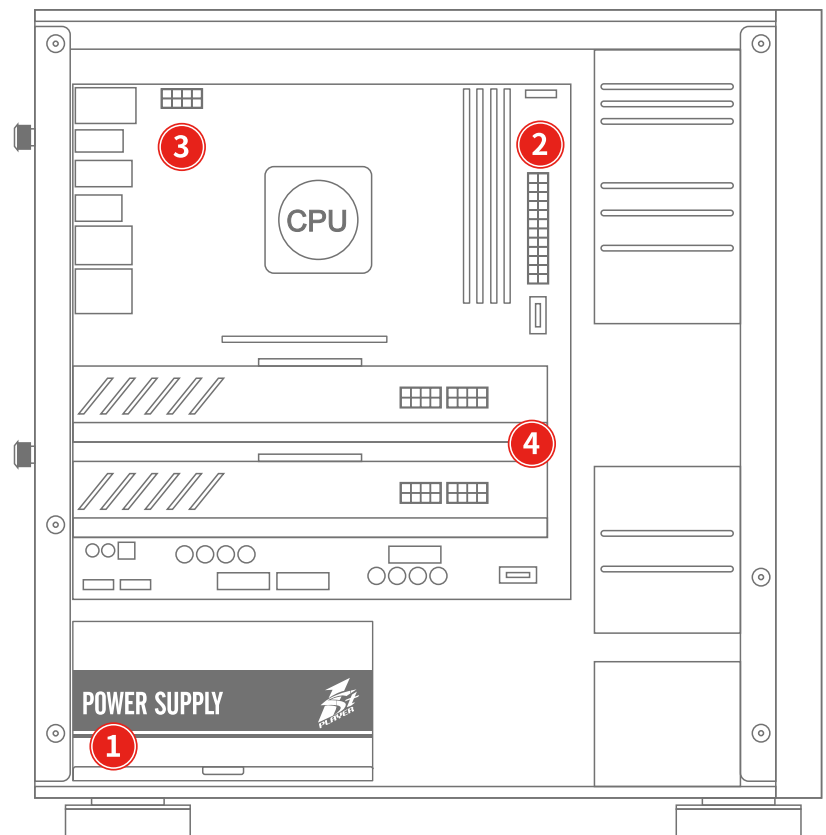
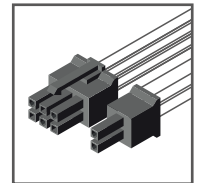

PC connection guide **Guideline**

- 5** SATA connector connects hard drive. IDE connector connects case fan.

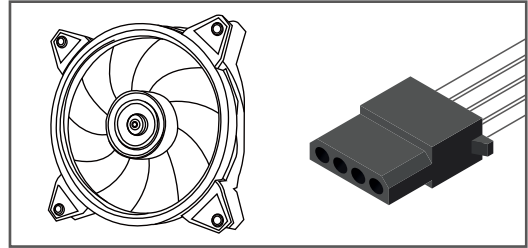
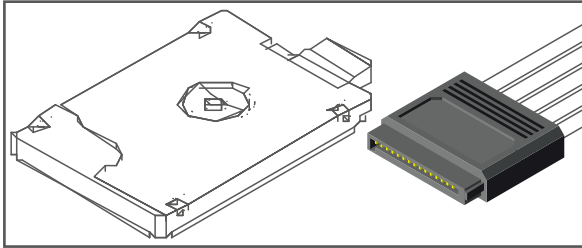

- 6** Connect the motherboard jumpers, USB connectors. (any connection problem please contact motherboard manufacturer)

- 7** Connect the power cord. Make sure the I/O button is on. Press the case power button to power on.

