



RS300-E12 Series

1U Rackmount Server User Guide



Copyright © 2024 ASUSTeK COMPUTER INC. All Rights Reserved.

No part of this manual, including the products and software described in it, may be reproduced, transmitted, transcribed, stored in a retrieval system, or translated into any language in any form or by any means, except documentation kept by the purchaser for backup purposes, without the express written permission of ASUSTeK COMPUTER INC. ("ASUS").

ASUS provides this manual "as is" without warranty of any kind, either express or implied, including but not limited to the implied warranties or conditions of merchantability or fitness for a particular purpose. In no event shall ASUS, its directors, officers, employees, or agents be liable for any indirect, special, incidental, or consequential damages (including damages for loss of profits, loss of business, loss of use or data, interruption of business and the like), even if ASUS has been advised of the possibility of such damages arising from any defect or error in this manual or product.

Specifications and information contained in this manual are furnished for informational use only, and are subject to change at any time without notice, and should not be construed as a commitment by ASUS. ASUS assumes no responsibility or liability for any errors or inaccuracies that may appear in this manual, including the products and software described in it.

Product warranty or service will not be extended if: (1) the product is repaired, modified or altered, unless such repair, modification or alteration is authorized in writing by ASUS; or (2) the serial number of the product is defaced or missing.

Products and corporate names appearing in this manual may or may not be registered trademarks or copyrights of their respective companies, and are used only for identification or explanation and to the owners' benefit, without intent to infringe.

Contents

Safety information.....	vii
About this guide.....	ix

Chapter 1: Product Introduction

1.1	System package contents.....	1-2
1.2	Serial number label.....	1-3
1.3	System specifications	1-4
1.4	Front panel features.....	1-7
1.5	Rear panel features.....	1-7
1.6	Internal features	1-8
1.7	LED information	1-10
1.7.1	Front panel LEDs	1-10
1.7.2	Storage device status LEDs.....	1-11
1.7.3	LAN (RJ-45) LEDs	1-12

Chapter 2: Hardware Information

2.1	Chassis cover.....	2-2
2.1.1	Removing the rear cover.....	2-2
2.2	Central Processing Unit (CPU)	2-3
2.2.1	Installing the CPU and heatsink.....	2-4
2.3	System memory	2-9
2.3.1	Installing a DIMM	2-10
2.4	Storage devices.....	2-11
2.4.1	Installing a 3.5-inch storage device.....	2-11
2.4.2	Installing a 2.5-inch storage device.....	2-13
2.5	Expansion slots.....	2-15
2.5.1	Installing an expansion card to the butterfly riser card.....	2-16
2.5.2	Installing an MCIO riser card to the butterfly riser card.....	2-18
2.5.3	Installing a LAN card to the proprietary slot	2-20
2.5.4	Installing a SlimSAS NVMe card to the proprietary slot.....	2-23
2.5.5	Installing an M.2 module	2-25
2.5.6	Installing a PFR module (optional)	2-28
2.5.7	Configuring an expansion card	2-29

Contents

- 2.6 Cable connections2-30
- 2.7 Backplane cabling2-31
- 2.8 Redundant power supply units (on selected models).....2-32
- 2.9 Motherboard2-33
 - 2.9.1 Removing the motherboard.....2-33
 - 2.9.2 Installing the motherboard.....2-34
- 2.10 CMOS battery2-35
- 2.11 Rail kit2-36

Chapter 3: Motherboard Information

- 3.1 Motherboard layout.....3-2
- 3.2 Jumpers3-4
- 3.3 Onboard LEDs.....3-9
- 3.4 Internal connectors.....3-11

Chapter 4: BIOS Setup

- 4.1 Managing and updating your BIOS4-2
 - 4.1.1 ASUS CrashFree BIOS 3 utility.....4-2
 - 4.1.2 ASUS EZ Flash Utility4-3
- 4.2 BIOS setup program4-4
 - 4.2.1 BIOS menu screen.....4-5
 - 4.2.2 Menu bar4-5
- 4.3 Main menu4-7
- 4.4 Performance Tuning menu.....4-8
- 4.5 Advanced menu4-9
 - 4.5.1 RC ACPI Settings.....4-10
 - 4.5.2 CPU Configuration4-11
 - 4.5.3 Power & Performance.....4-13
 - 4.5.4 System Agent (SA) Configuration4-17
 - 4.5.5 PCH Configuration4-19
 - 4.5.6 Server ME Configuration.....4-22
 - 4.5.7 Server ME Debug Configuration4-23
 - 4.5.8 Thermal Configuration.....4-24
 - 4.5.9 Platform Settings.....4-25
 - 4.5.10 BCLK Configuration4-27

Contents

4.5.11	System Event Log	4-28
4.5.12	Debug Settings.....	4-29
4.5.13	Debug Configuration	4-30
4.5.14	Trusted Computing.....	4-31
4.5.15	ACPI Settings.....	4-31
4.5.16	Redfish Host Interface Settings.....	4-32
4.5.17	SMART Settings.....	4-32
4.5.18	Onboard LAN Configuration.....	4-33
4.5.19	UEFI Variables Protection.....	4-33
4.5.20	Serial Port Console Redirection	4-34
4.5.21	Intel TXT Information.....	4-37
4.5.22	Acoustic Management Configuration	4-37
4.5.23	AMI Graphic Output Protocol Policy.....	4-37
4.5.24	SIO Common Setting	4-38
4.5.25	SIO Configuration.....	4-38
4.5.26	PCI Subsystem Settings	4-39
4.5.27	USB Configuration	4-40
4.5.28	Network Stack Configuration.....	4-42
4.5.29	NVMe Configuration.....	4-43
4.5.30	APM Configuration	4-43
4.5.31	Third-party UEFI driver configurations	4-44
4.5.32	Driver Health	4-44
4.6	Security menu	4-45
4.7	Boot menu	4-49
4.8	Tool menu.....	4-51
4.9	Event Logs menu	4-52
4.9.1	Change Smbios Event Log Settings	4-52
4.9.2	View Smbios Event Log	4-52
4.10	Server Mgmt menu.....	4-53
4.11	Exit menu	4-55

Contents

- Chapter 5: RAID Configuration**
 - 5.1 Setting up RAID..... 5-2**
 - 5.1.1 RAID definitions 5-2
 - 5.1.2 Installing hard disk drives..... 5-3
 - 5.1.3 Setting the RAID item in BIOS 5-3
 - 5.2 Intel® Virtual Raid on CPU in BIOS..... 5-4**
 - 5.2.1 Creating a RAID set 5-5
 - 5.2.2 Deleting a RAID set..... 5-6
 - 5.3 Intel® Rapid Storage Technology enterprise (Windows)..... 5-7**
 - 5.3.1 Creating a RAID set 5-8
 - 5.3.2 Changing a Volume Type..... 5-10
 - 5.3.3 Deleting a volume 5-11
 - 5.3.4 Preferences..... 5-12

- Chapter 6: Driver Installation**
 - 6.1 RAID driver installation 6-2**
 - 6.1.1 Creating a USB flash drive with RAID drive..... 6-2
 - 6.1.2 Installing the RAID controller driver..... 6-2
 - 6.2 Running the Support DVD..... 6-5**

- Appendix**
 - Block diagram A-2**
 - Q-Code table..... A-3**
 - Notices A-5**
 - Service and Support A-11**

Safety information

Electrical Safety

- Before installing or removing signal cables, ensure that the power cables for the system unit and all attached devices are unplugged.
- To prevent electrical shock hazard, disconnect the power cable from the electrical outlet before relocating the system.
- When adding or removing any additional devices to or from the system, ensure that the power cables for the devices are unplugged before the signal cables are connected. If possible, disconnect all power cables from the existing system before you add a device.
- If the power supply is broken, do not try to fix it by yourself. Contact a qualified service technician or your dealer.

Operation Safety

- Any mechanical operation on this server must be conducted by certified or experienced engineers.
- Before operating the server, carefully read all the manuals included with the server package.
- Before using the server, ensure all cables are correctly connected and the power cables are not damaged. If any damage is detected, contact your dealer as soon as possible.
- To avoid short circuits, keep paper clips, screws, and staples away from connectors, slots, sockets and circuitry.
- Avoid dust, humidity, and temperature extremes. Place the server on a stable surface.
- If you encounter technical problems with the product, contact a qualified service technician or your retailer.



This product is equipped with a three-wire power cable and plug for the user's safety. Use the power cable with a properly grounded electrical outlet to avoid electrical shock.

Restricted Access Area

This equipment should only be installed in a Restricted Access Area where both these conditions apply:

- Access can only be gained by skilled or instructed persons who have been instructed about the reasons for the restrictions applied to the area and about any precautions that shall be taken; and
- Access is through the use of a TOOL, or other means of security, and is controlled by the authority responsible for the area.

Lithium-Ion Battery Warning

CAUTION! Danger of explosion if battery is incorrectly replaced. Replace only with the same or equivalent type recommended by the manufacturer. Dispose of used batteries according to the manufacturer's instructions.

Heavy System

CAUTION! This server system is heavy. Ask for assistance when moving or carrying the system.

Shock Hazard



CAUTION! Risk of electric shock.
Disconnect all power supply input plugs before servicing.

Optical Drive Safety Information

Laser Safety Information

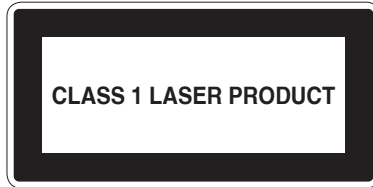

To prevent exposure to the optical drive's laser, do not attempt to disassemble or repair the optical drive by yourself. For your safety, contact a professional technician for assistance.

About this guide

Audience

This user guide is intended for system integrators, and experienced users with at least basic knowledge of configuring a server.

Contents

This guide contains the following parts:

1. Chapter 1: Product Introduction

This chapter describes the general features of the server, including sections on front panel and rear panel specifications.

2. Chapter 2: Hardware Information

This chapter lists the hardware setup procedures that you have to perform when installing or removing system components.

3. Chapter 3: Motherboard Information

This chapter gives information about the motherboard that comes with the server. This chapter includes the motherboard layout, jumper settings, and connector locations.

4. Chapter 4: BIOS Setup

This chapter tells how to change system settings through the BIOS Setup menus and describes the BIOS parameters.

5. Chapter 5: RAID Installation

This chapter provides instructions for setting up, creating, and configuring RAID sets using the available utilities.

6. Chapter 6: Driver Installation

This chapter provides instructions for installing the necessary drivers for different system components.

Conventions

To ensure that you perform certain tasks properly, take note of the following symbols used throughout this manual.



DANGER/WARNING: Information to prevent injury to yourself when trying to complete a task.



CAUTION: Information to prevent damage to the components when trying to complete a task.



IMPORTANT: Instructions that you **MUST** follow to complete a task.



NOTE: Tips and additional information to help you complete a task.

Typography

Bold text

Indicates a menu or an item to select.

Italics

Used to emphasize a word or a phrase.

<Key>

Keys enclosed in the less-than and greater-than sign means that you must press the enclosed key.

Example: <Enter> means that you must press the Enter or Return key.

<Key1>+<Key2>+<Key3>

If you must press two or more keys simultaneously, the key names are linked with a plus sign (+).

Example: <Ctrl>+<Alt>+

Command

Means that you must type the command exactly as shown, then supply the required item or value enclosed in brackets.

Example: At the command prompt, type the command line: **format A:/S**

References

Refer to the following sources for additional information, and for product and software updates.

1. **ASUS Control Center (ACC) user guide**

This manual tells how to set up and use the proprietary ASUS server management utility. Visit [asuscontrolcenter.asus.com](https://www.asus.com/asuscontrolcenter) for more information.

2. **ASUS websites**

The ASUS websites provide updated information for all ASUS hardware and software products. Visit <https://www.asus.com> for more information.

Product Introduction

1

This chapter describes the general features of the chassis kit. It includes sections on front panel and rear panel specifications.

1.1 System package contents

Check your system package for the following items.

Model name	RS300-E12-RS4, RS300-E12-PS4
Chassis	ASUS 1U rackmount chassis
Motherboard	ASUS P13R-M/SYS server board
Component	1 x 350W single power supply (RS300-E12-PS4 only) 1 x 450W 1+1 redundant power supply (RS300-E12-RS4 only) 4 x 3.5-inch storage device trays or dummy trays 1 x SAS/SATA/NVMe backplane 1 x SATA to SLIMSAS cable 1 x PCI Express riser card 1 x Front I/O board 6 x System fans (40 mm x 28 mm)
Accessories	1 x Bag of screws 1 x AC power cable (RS300-E12-PS4 only) 2 x AC power cable (RS300-E12-RS4 only) 1 x CPU heatsink
Optional Items	1 x Slim-type DVD-ROM/DVD-RW optical drive 1 x Additional 450W redundant power supply (RS300-E12-RS4 only) 1 x Single power supply module 1 x SLIMSAS riser card (supports two Gen4 NVMe) 1 x MCIO riser card (supports two Gen5 NVMe) 1 x MCIO to SLIMSAS cable 1 x X710 card (proprietary slot) 1 x PEI-1G/I210-2T/M.2 card (proprietary slot) 1 x Friction rail kit



If any of the above items is damaged or missing, contact your retailer.

1.2 Serial number label

The product's serial number contains 12 characters such as xxSxxxxxxx and printed on the sticker at the server's front cover.

The correct serial number of the product is required if you need to request support from the ASUS Technical Support team.

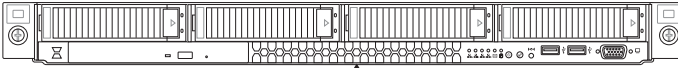

1.3 System specifications

The ASUS RS300-E12 Series features the ASUS P13R-M/SYS server board. The server supports Intel® Xeon® E-2400 and Intel® Pentium™ processors plus other latest technologies through the chipsets onboard.

Model name		RS300-E12-RS4	RS300-E12-PS4
Motherboard		P13R-M/SYS	
Processor support		1 x Socket V (LGA 1700) Intel® Xeon® E-2400 processor (up to 95W) Intel® Pentium™ processor	
Core logic		Intel® C262 Chipset	
Memory	Total slots	4 (2-channels)	
	Capacity	Maximum up to 128GB UDIMM	
	Memory type	DDR5 4400/4000/3600 ECC UDIMM * Refer to ASUS server AVL for the latest update	
	Memory size	32GB, 16GB, 8GB UDIMM	
Expansion slots	Total PCI/PCIe/PIKE slots	Up to 3	
	Slot type	<u>Butterfly riser slot A:</u> 1 x PCIe (Gen5 x16 link, x8 link when slot B is occupied, FH/HL) <u>Butterfly riser slot B:</u> 1 x PCIe (Gen5 x8 link, HH/HL)	
	M.2	1 x M.2 (up to 2280, from PCH, supports PCIe M.2)	
	Proprietary slot 1	<u>Motherboard slot C:</u> 1 x PCIe (Gen4 x4 link, proprietary R/A slot*) * For Intel X710 10G, SlimSAS NVMe, or PEI-1G/1210-2T/M.2 cards	
Storage	SATA controller	8 x SATA 6Gb/s ports	
	SAS controller	ASUS PIKE II 3108 8-port SAS HW 12Gb/s RAID card (optional)	

(continued on the next page)

Model name		RS300-E12-RS4	RS300-E12-PS4
Storage bays	Storage bay	4 x 3.5-inch hot-swap storage bays (up to 4 x SATA/SAS/NVMe) * SAS support requires an optional SAS HBA/RAID card * NVMe support requires an optional NVMe upgrade kit	
	Backplane connectors	2 x MCIO connectors 1 x SLIMSAS connector	
	Motherboard on-board connectors	8 x 7-pin SATA connectors 1 x M.2 connector	
	Default cables	1 x SATA to SLIMSAS cable	
	NVMe upgrade option	NVMe upgrade options 1 x NVMe (Gen4x4) from SLIMSAS x4 connector or SLIMSAS riser card 2 x NVMe (Gen5x4) from MCIO riser card 4 x NVMe (2 x Gen5x4, 2x Gen4x4) from SLIMSAS connectors and MCIO riser card or SLIMSAS riser card	
Networking		2 x Intel® I210-AT 1 x Management port	
Graphic		Aspeed AST2600 64MB	
Auxiliary storage device bay		1 x Slim-type DVD-RW/DVD-ROM optical drive (optional)	
Front I/O ports		1 x VGA port 2 x USB 3.2 Gen 1 ports	
Rear I/O ports		3 x USB 3.2 Gen 2 ports 1 x VGA port 1 x COM port 2 x RJ-45 ports 1 x RJ-45 ports (for ASMB11-iKVM)	
Switch/LED		Rear Switch/LED: 1 x Q-Code/Port 80 LED 1 x Power switch Front Switch/LED: 1 x Power switch/LED 1 x Location switch/LED 1 x Reset switch 1 x HDD Access LED 1 x Message LED 2 x LAN LED	

(continued on the next page)

Model name		RS300-E12-RS4	RS300-E12-PS4
OS support		Windows Server 2022, Azure Stack HCI, SuSE® Linux Enterprise Server, VMM * Refer to https://servers.asus.com/support/os for the latest supported OS list	
Management solution	Software	ASUS Control Center	
	Out of band remote management	Onboard ASMB11-iKVM for KVM-over-IP	
Regulatory compliance		BSMI, CE, CB, FCC (Class A)	
Dimension		497mm x 439.5mm x 44mm (1U)	
Net weight		9.19kg	8.14kg
		(excluding CPU, DRAM, and HDD)	
Gross weight		15.97kg	14.66kg
		(including packaging, excluding CPU, DRAM, and HDD)	
Power supply (different configuration by region)		1+1 redundant 450W 80 PLUS Platinum power supply Rating: 100-240V~, 8A (for each inlet), 50/60Hz	Single 350W 80 PLUS Gold power supply Rating: 100-240V~, 6A-3A, 50/60Hz
Environment		Operating temperature: 10°C ~ 35°C Non-operating temperature: -40°C ~ 70°C Non-operating humidity: 20% ~ 90% (Non-condensing)	



Specifications are subject to change without notice.

1.4 Front panel features

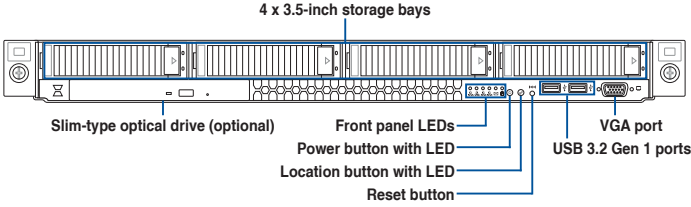

Bays 1 to 4 support SATA/SAS/NVMe. SAS support requires an optional HBA/RAID card.

1.5 Rear panel features

RS300-E12-RS4

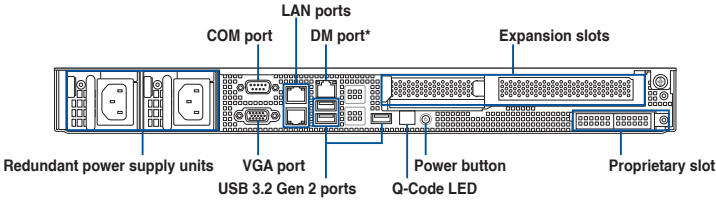

RS300-E12-PS4

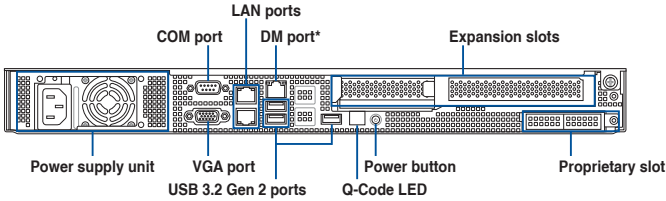

The DM (Dedicated Management) port is for ASUS ASMB11-iKVM only.

1.6 Internal features

RS300-E12-RS4

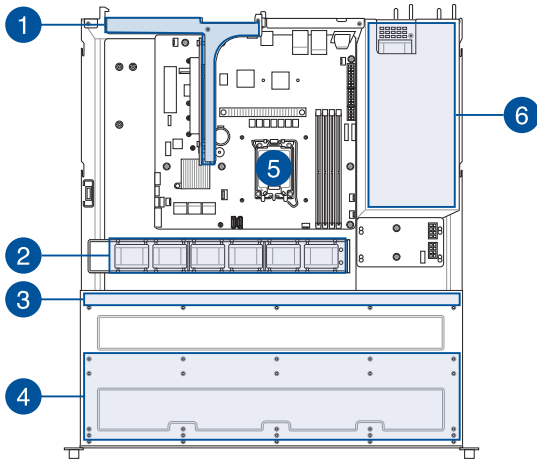

RS300-E12-PS4

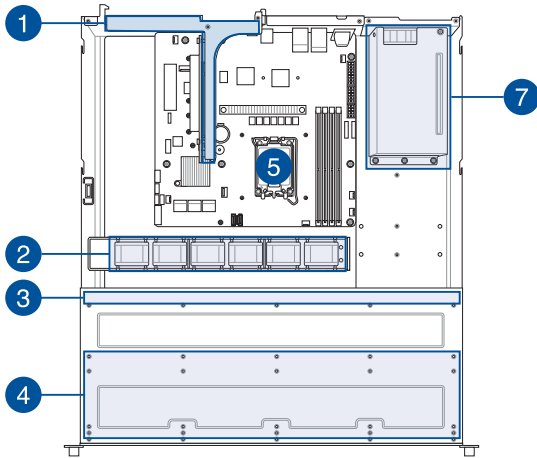

1. PCIe riser card
2. System fans
3. SATA/SAS/NVMe backplane
4. 4 x 3.5-inch storage bays
5. Motherboard
6. Redundant 1+1 power supply units
7. Single power supply unit



The barebone server does not include a floppy disk drive. Connect a USB floppy disk drive to any of the USB ports on the front or rear panel if you need to use a floppy disk.



A protection film is pre-attached to the front cover before shipping. Please remove the protection film before turning on the system for proper heat dissipation.

WARNING
HAZARDOUS MOVING PARTS
KEEP FINGERS AND OTHER BODY PARTS AWAY

1.7 LED information

1.7.1 Front panel LEDs

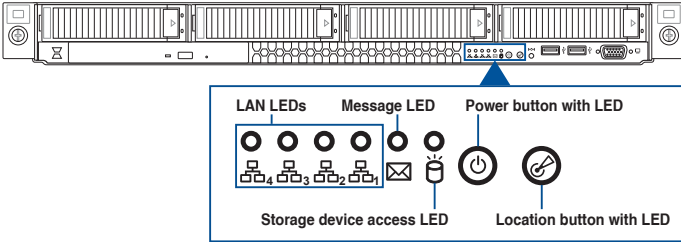

LED	Icon	Display status	Description
LAN LEDs		ON	LAN connection is present
		Blinking	LAN is transmitting or receiving data
		OFF	No LAN connection
Message LED		ON	A hardware monitor event is indicated
		OFF	System is normal; no incoming event
Storage device access LED		Blinking	Storage device reading or writing data
		OFF	No activity
Power LED		ON	System power on
Location LED		ON	Location switch is pressed (press the location switch again to turn off)
		OFF	Function off

1.7.2 Storage device status LEDs

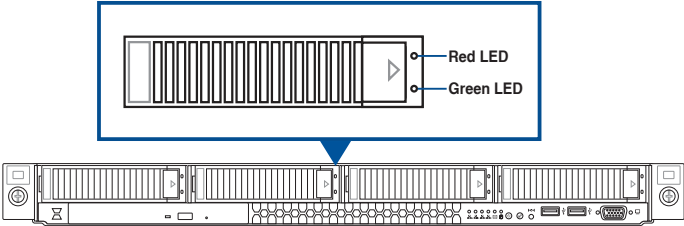

Storage Device LED Description		
Status (RED)	ON	Storage device has failed
	Blinking	RAID rebuilding or locating
Activity (GREEN)	ON	Storage device power ON
	Blinking	Storage device reading or writing data
	OFF	Storage device not found

1.7.3 LAN (RJ-45) LEDs

Intel® I210-AT LAN port LEDs

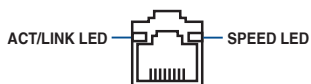

SPEED LED		ACT/LINK LED	
Status	Description	Status	Description
OFF	10 Mbps connection	OFF	No link
ORANGE	100 Mbps connection	GREEN	Linked
GREEN	1 Gbps connection	BLINKING	Data activity

Dedicated Management LAN port (DM_LAN1) LED indications

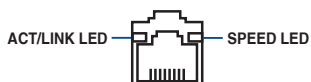

SPEED LED		ACT/LINK LED	
Status	Description	Status	Description
OFF	10 Mbps connection	OFF	No link
ORANGE	100 Mbps connection	GREEN	Linked
GREEN	1 Gbps connection	BLINKING	Data activity

Hardware Information

2

This chapter lists the hardware setup procedures that you have to perform when installing or removing system components.

2.1 Chassis cover

2.1.1 Removing the rear cover

1. Remove the two (2) screws on both sides of the rear cover.
2. Loosen the thumbscrew on the rear of the chassis.
3. Slide the rear cover towards the rear panel, then lift to remove the rear cover from the chassis.

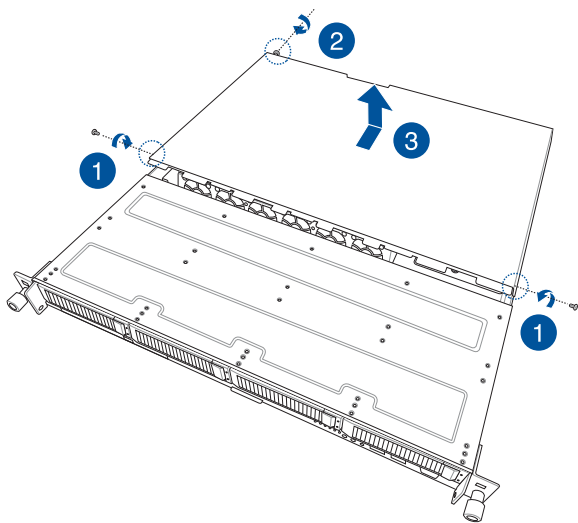

2.2 Central Processing Unit (CPU)

The motherboard comes with a Socket V (LGA1700) designed for the Intel® Xeon® E-2400 (up to 95W) and Intel® Pentium™ processors.

P13R-M_10G-2T CPU LGA1700

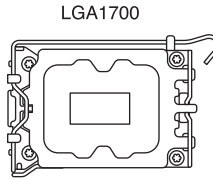
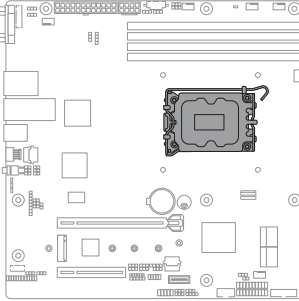

Ensure that you install the correct CPU designed for the socket only. DO NOT install a CPU designed for other sockets on the socket.



- Ensure that all power cables are unplugged before installing the CPU.
 - Upon purchase of the motherboard, ensure that the PnP cap is on the socket and the socket contacts are not bent. Contact your retailer immediately if the PnP cap is missing, or if you see any damage to the PnP cap/socket contacts/motherboard components. ASUS will shoulder the cost of repair only if the damage is shipment/transit-related.
 - Keep the cap after installing the motherboard. ASUS will process Return Merchandise Authorization (RMA) requests only if the motherboard comes with the cap on the socket.
 - The product warranty does not cover damage to the socket contacts resulting from incorrect CPU installation/removal, or misplacement/loss/incorrect removal of the PnP cap.
-

2.2.1 Installing the CPU and heatsink

To install the CPU and heatsink:

1. Press the load lever with your thumb, then move it to the right until it is released from the retention tab.

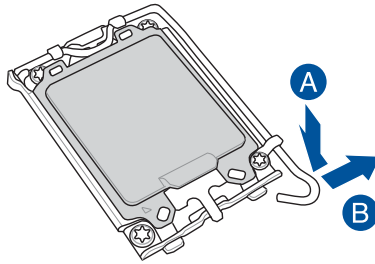

- Do not remove the PnP cap from the CPU socket yet. Doing so may cause damage to the pins of the socket.
- Take caution when lifting the load lever, ensure to hold onto the load lever when releasing the load lever. Letting go of the load lever immediately after releasing it may cause the load lever to spring back and cause damage to your motherboard.

2. Lift the load lever, then lift the load plate.

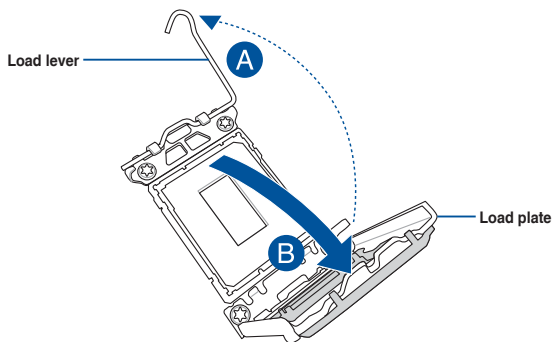

3. Position the CPU above the socket and ensure that the triangle mark is aligned with the corresponding triangle mark on the socket, then align the CPU notches with the alignment keys on the socket and install the CPU.

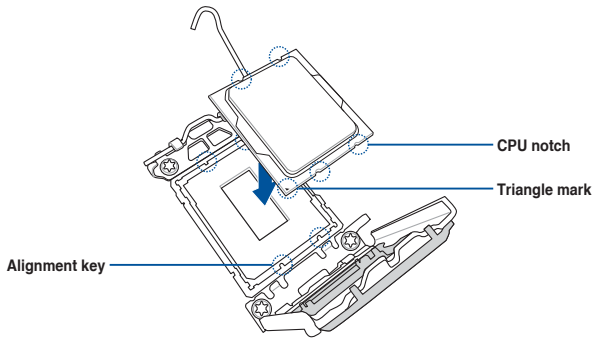

The CPU fits in only one orientation. DO NOT force the CPU into the socket to prevent bending the pins on the socket and damaging the CPU.

4. Close the load plate, then move the load lever to the closed position.

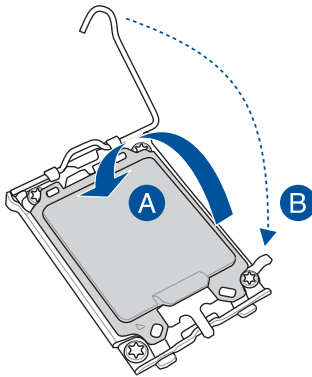

5. Slide the load lever under the retention tab, then remove the PnP cap.

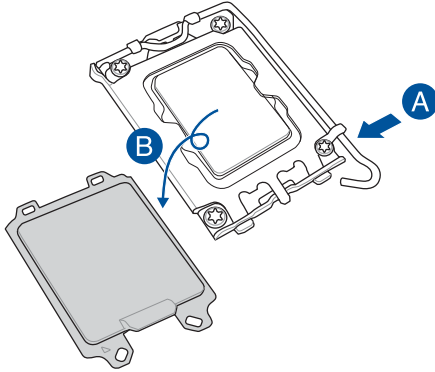

6. Apply some Thermal Interface Material to the exposed area of the CPU that the heatsink will be in contact with, ensuring that it is evenly spread in a thin layer.

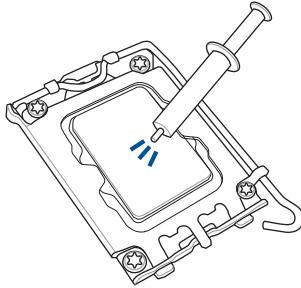

Some heatsinks come with pre-applied Thermal Interface Material. If so, skip this step.



The Thermal Interface Material is toxic and inedible. **DO NOT** eat it. If it gets into your eyes or touches your skin, wash it off immediately and seek professional medical help.

7. Align the heatsink to the CPU socket, then twist each of the four screws with a screwdriver just enough to attach the heatsink to the motherboard. When the four screws are attached, tighten them one by one in the sequence shown in the illustration to completely secure the heatsink.



A T20 screwdriver with a torque value of 4.5 ± 0.5 kgf-cm is recommended.

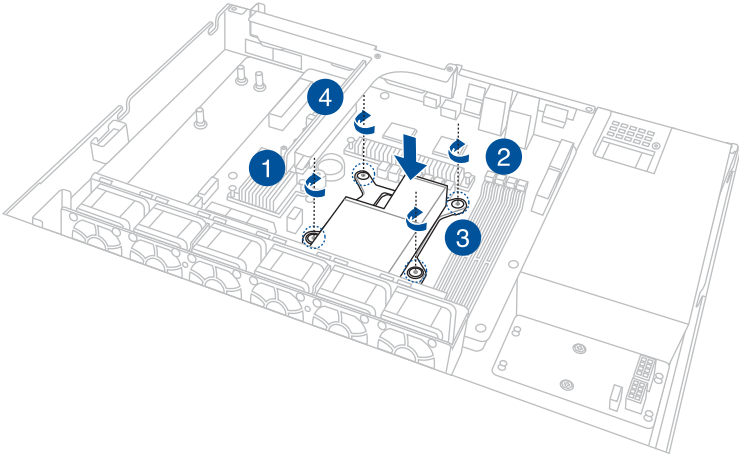

8. Install the air duct.

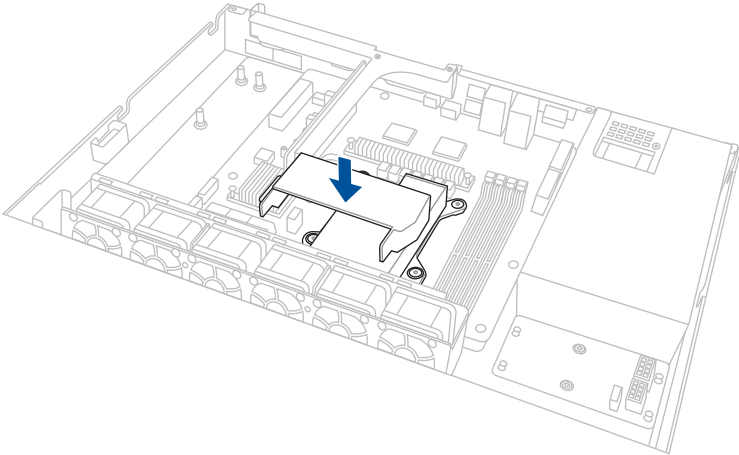

9. Secure the air duct using the bundled screw.

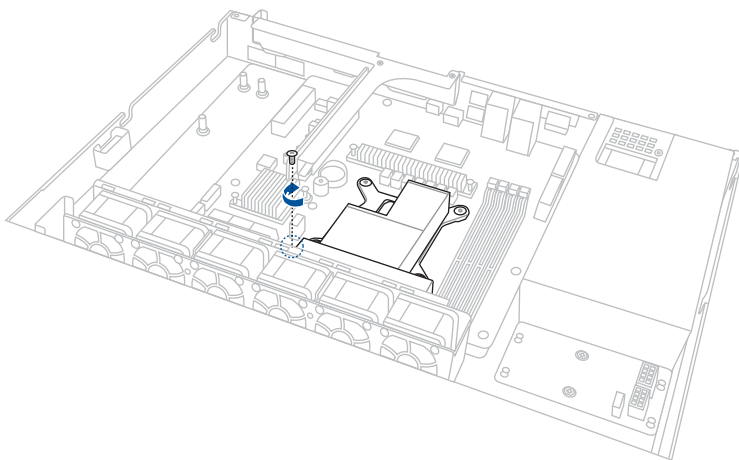

2.3 System memory

The motherboard comes with 4 Double Data Rate 5 (DDR5) Dual Inline Memory Modules (DIMM) sockets.

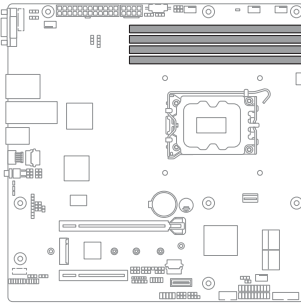

Recommended memory configuration

You may install 8GB, 16GB, or 32GB UDIMM into the DIMM sockets. Refer to the below table for the recommended memory population configuration.



Always install DIMMs with the same CAS latency. For optimum compatibility, it is recommended that you obtain memory modules from the same vendor.

Recommended configuration				
	A1	A2	B1	B2
1 DIMM		•		
2 DIMMs		•		•
4 DIMMs	•	•	•	•

2.3.1 Installing a DIMM



Ensure to unplug the power supply before adding or removing DIMMs or other system components. Failure to do so may cause severe damage to both the motherboard and the components.

1. Unlock a DIMM socket by pressing the retaining clip outward.
2. Align a DIMM on the socket such that the notch on the DIMM matches the DIMM slot key on the socket.

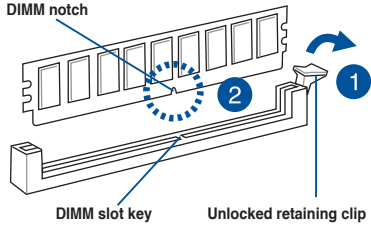

A DIMM is keyed with a notch so that it fits in only one direction. DO NOT force a DIMM into a socket in the wrong direction to avoid damaging the DIMM.

3. Hold the DIMM by both of its ends then insert the DIMM vertically into the socket. Apply force to both ends of the DIMM simultaneously until the retaining clip snaps back into place and the DIMM cannot be pushed in any further to ensure proper sitting of the DIMM.

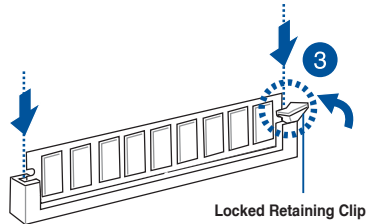

Always insert the DIMM into the socket vertically to prevent DIMM notch damage.

Removing a DIMM from a single clip DIMM socket

1. Press the retaining clip outward to unlock the DIMM.
2. Remove the DIMM from the socket.

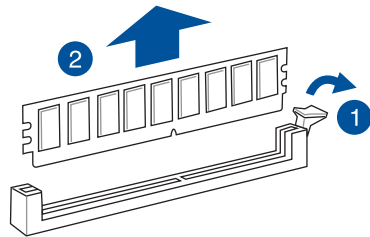

Support the DIMM lightly with your fingers when pressing the retaining clips. The DIMM might get damaged when it flips out with extra force.

2.4 Storage devices

The system supports four 3.5-inch hot-swap SATA/SAS/NVMe storage devices. The storage devices installed on the storage device tray connect to the motherboard SATA/SAS/NVMe ports via the SATA/SAS/NVMe backplane.

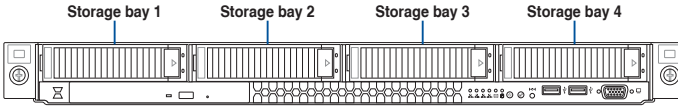

Bays 1 to 4 support SATA/SAS/NVMe. SAS support requires an optional HBA/RAID card.

2.4.1 Installing a 3.5-inch storage device

1. Press the spring lock to release the tray lever and partially eject the tray from the bay.

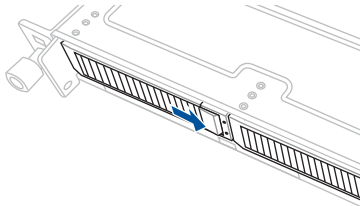

2. Firmly hold the tray lever and pull the storage device tray out of the bay.

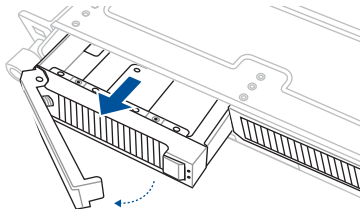

3. Place the 3.5-inch storage device into the tray, then push down until the 3.5-inch storage device clicks into place.

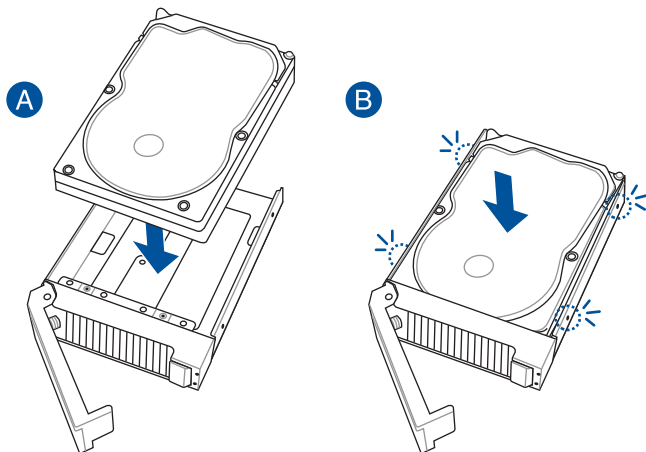

4. Carefully insert the tray and push it all the way into the storage bay, then use the tray lever to lock the drive tray in place.

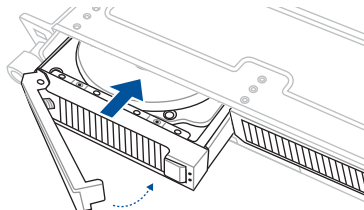

2.4.2 Installing a 2.5-inch storage device

1. Press the spring lock to release the tray lever and partially eject the tray from the bay.

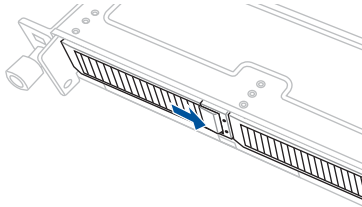

2. Firmly hold the tray lever and pull the storage device tray out of the bay.

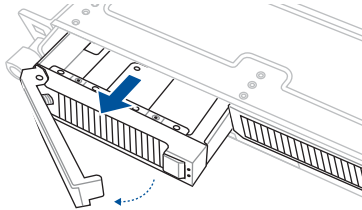

3. Align the 2.5-inch storage device with the screw holes on the tray, then secure the 2.5-inch storage device using the bundled screws.

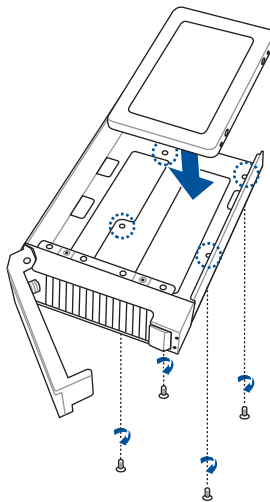

4. Carefully insert the tray and push it all the way into the storage bay, then use the tray lever to lock the drive tray in place.

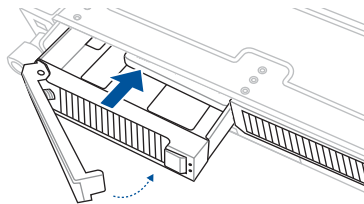

2.5 Expansion slots

The barebone server comes with up to 3 PCIe slots. One of the slots is pre-installed with a butterfly riser card bracket for installing PCIe expansion cards. Remove the butterfly riser card bracket before installing additional PCIe expansion cards.

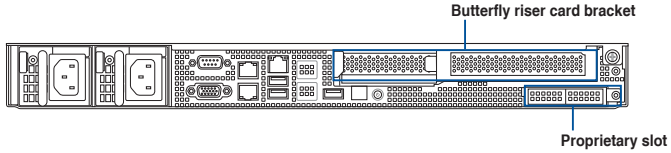

Butterfly riser card bracket

PCIe slot	Operation mode	
	Mode 1	Mode 2
Slot 1	x16	x8
Slot 2	-	x8

Proprietary slot

PCIe slot	Operation mode	
	Mode 1	Mode 2
Slot 3	-	x4

2.5.1 Installing an expansion card to the butterfly riser card

The pre-installed butterfly riser card provides a PCIe x16 slot (Gen5 x16 link, or Gen5 x8 link when slot B is occupied) and a PCIe x8 slot (Gen5 x8 link).

1. Lift and remove the butterfly riser card bracket from the chassis.

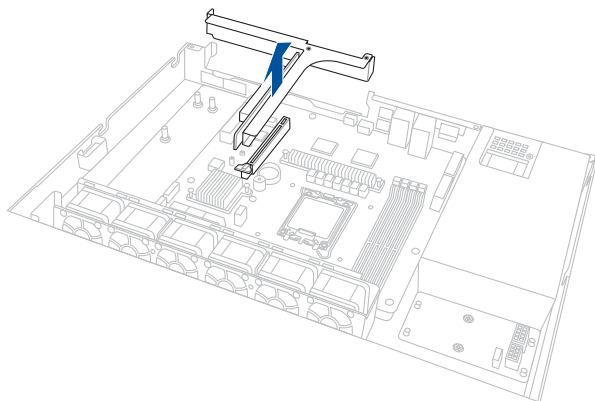

2. Disengage the slot cover locks, then remove the slot covers.

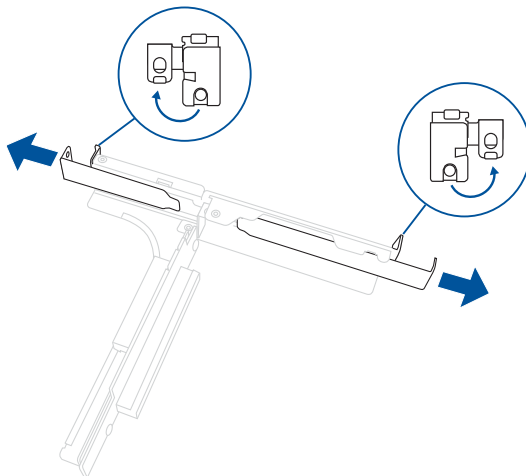

3. Install the expansion card into the PCIe slot on the butterfly riser card, then secure the expansion card using the slot cover locks.

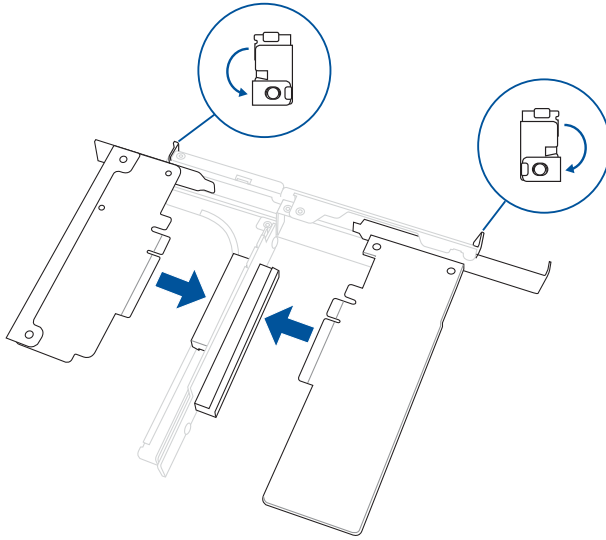

4. Install the butterfly riser card bracket back into the PCIe slot on the motherboard and ensure that the golden connectors of the butterfly riser card bracket are firmly seated in place.

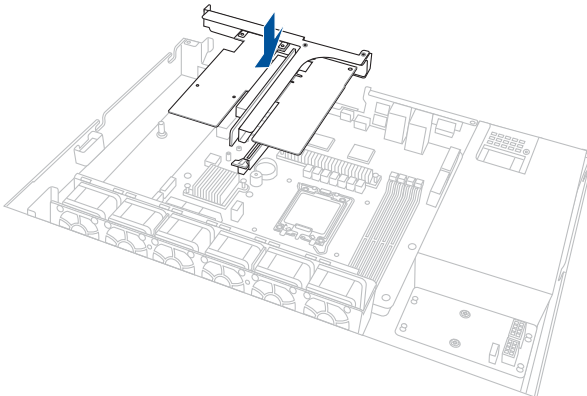

2.5.2 Installing an MCIO riser card to the butterfly riser card

1. Lift and remove the butterfly riser card bracket from the chassis.

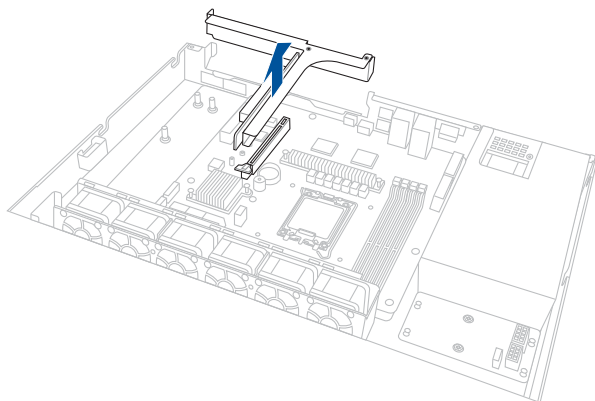

2. Remove the screws, then remove the butterfly riser card.

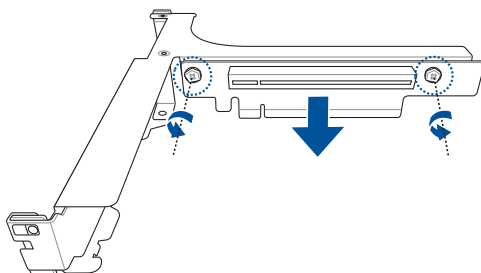

3. Install the MCIO riser card, then secure the MCIO riser card using the screws you removed earlier.

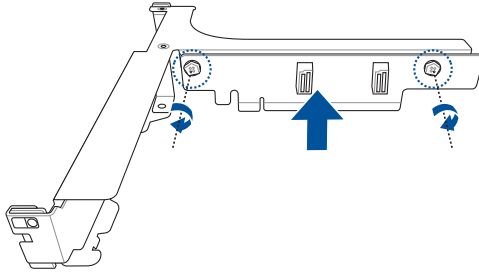

4. Install the butterfly riser card bracket back into the PCIe slot on the motherboard and ensure that the golden connectors of the butterfly riser card bracket are firmly seated in place.

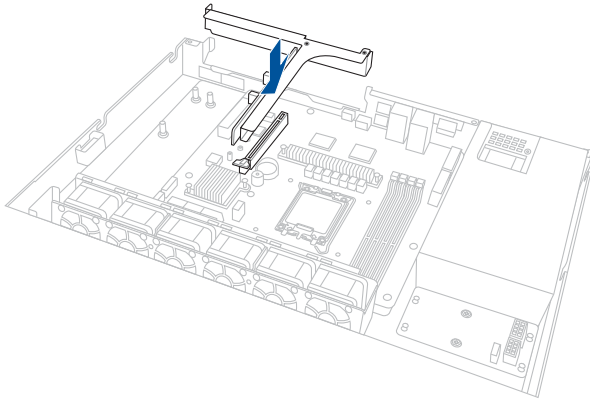

2.5.3 Installing a LAN card to the proprietary slot

The onboard proprietary slot provides a PCIe x4 slot (Gen4 x4 link) and allows you to install an Intel® X710 10G LAN card or PEI-1G/1120-2T/M.2 LAN card.

1. Lift and remove the butterfly riser card bracket from the chassis.

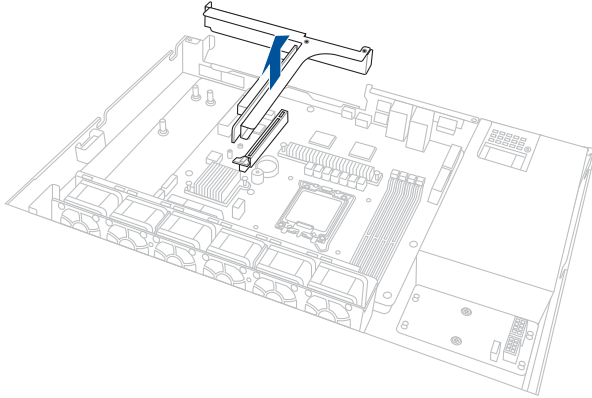

2. Remove the screw from the slot cover on the rear of the chassis, then remove the slot cover.

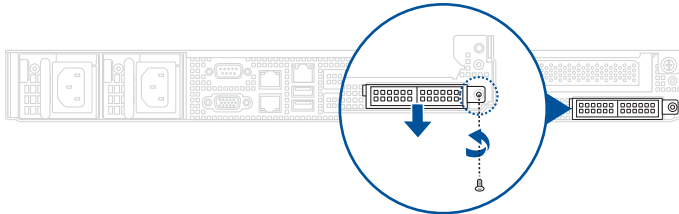

3. Remove the metal cover from the slot cover.



Take extra care when removing the metal cover. Use tools such as a screw driver to bend and remove the metal cover to avoid physical injury.

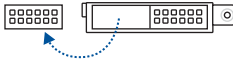

4. Replace the slot cover and secure it to the chassis using the screw removed previously.

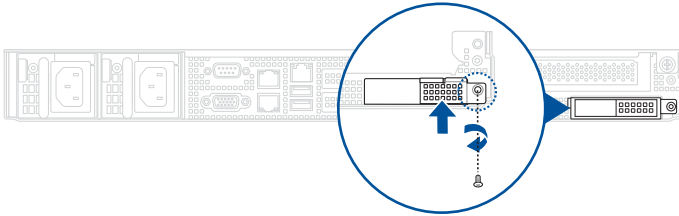

5. Install the LAN card to the onboard PCIe slot, then secure it with the bundled screws.



Ensure that the LAN ports are aligned with the opening in the slot cover.

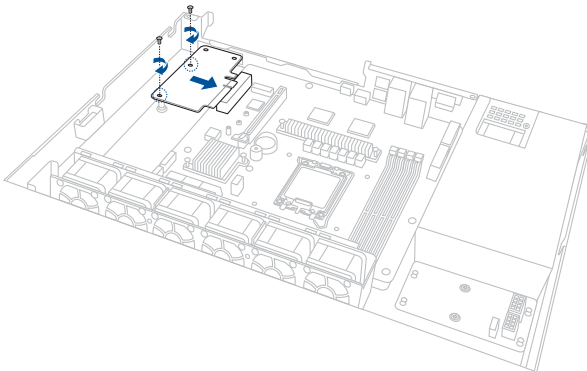

6. Install the butterfly riser card bracket back into the PCIe slot on the motherboard and ensure that the golden connectors of the butterfly riser card bracket are firmly seated in place.

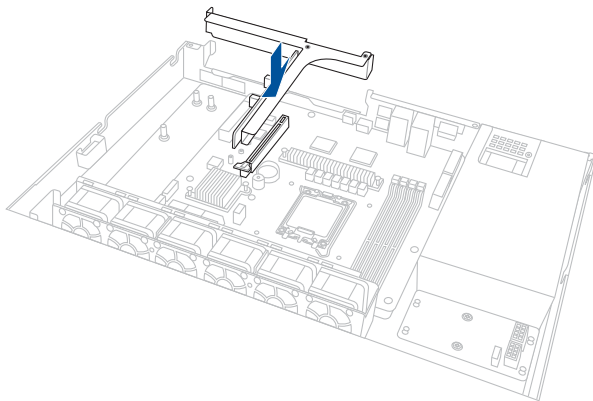

2.5.4 Installing a SlimSAS NVMe card to the proprietary slot

The onboard proprietary slot provides a PCIe x4 slot (Gen4 x4 link) and allows you to install a SlimSAS NVMe card.

1. Lift and remove the butterfly riser card bracket from the chassis.

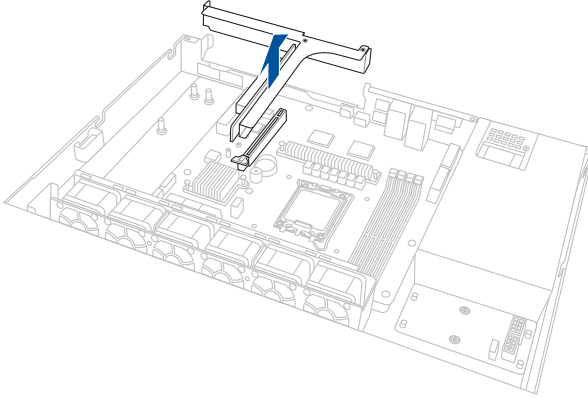

2. Install the SlimSAS NVMe card to the onboard PCIe slot, then secure it with the bundled screws.

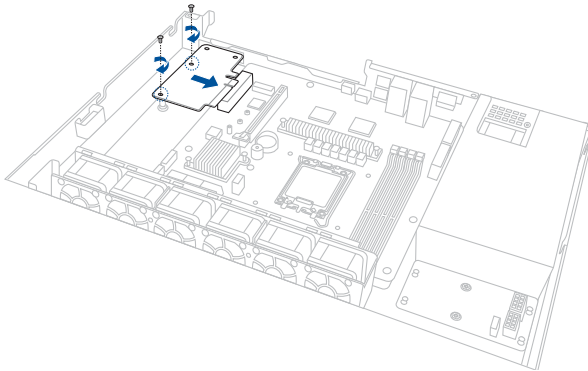

3. Install the butterfly riser card bracket back into the PCIe slot on the motherboard and ensure that the golden connectors of the butterfly riser card bracket are firmly seated in place.

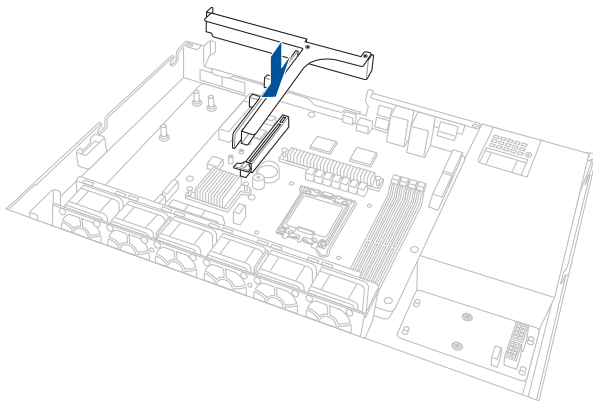

2.5.5 Installing an M.2 module



- The M.2 connector supports type 2242/2260/2280 devices on both PCIe x4 and NVMe interfaces.
- The M.2 (NGFF) device is purchased separately.

1. Lift and remove the butterfly riser card bracket from the chassis.

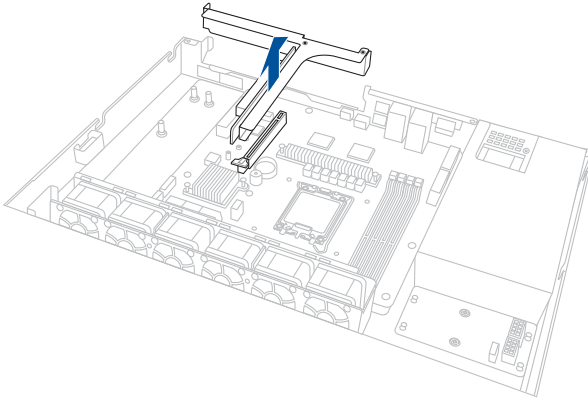

2. Locate the M.2 slot (M.2_1(SOCKET3)) on the motherboard.

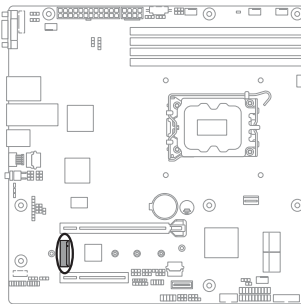

M.2_1(SOCKET3)



2242



2260



2280

3. Remove the screw on the stand screw.

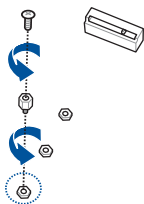

4. Adjust the position of the stand screw (optional).

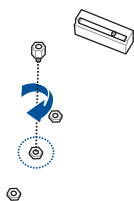

5. Align and insert the M.2 module into the M.2 slot, then secure the M.2 module with the screw you removed earlier.

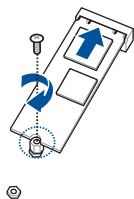

6. Install the butterfly riser card bracket back into the PCIe slot on the motherboard and ensure that the golden connectors of the butterfly riser card bracket are firmly seated in place.

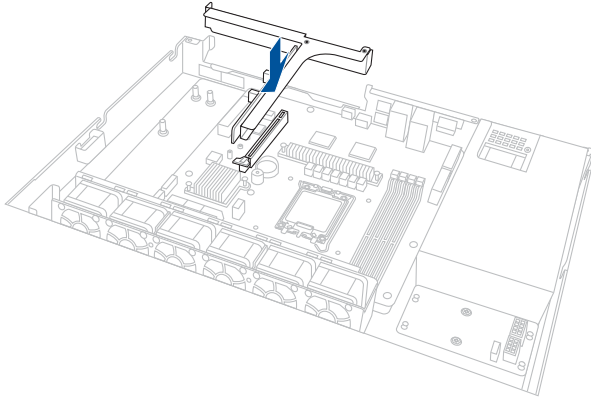

2.5.6 Installing a PFR module (optional)

The optional PFR module will come pre-installed on your system and is connected to the PFR module connector on your motherboard.



- The illustration below is for reference only.
- For more information or assistance, please refer to www.asus.com.

1. Locate the PFR module connector on your motherboard.

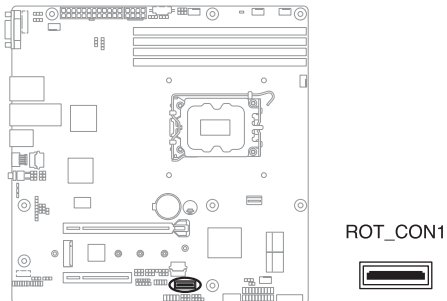

2. Align and connect the PFR module to the PFR module connector.

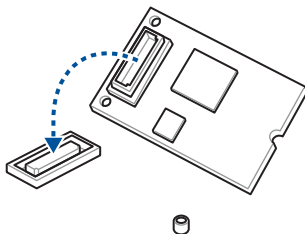

3. Push the PFR module down so that it is seated securely on the PFR module connector, then secure it using a screw.

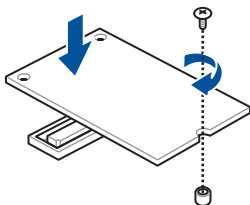

2.5.7 Configuring an expansion card

After installing the expansion card, configure it by adjusting the software settings.

1. Turn on the system and change the necessary BIOS settings, if any. See the **BIOS Setup** chapter for information on BIOS setup.
2. Assign an IRQ to the card. Refer to the following tables.
3. Install the software drivers for the expansion card.

IRQ	Priority	Standard function
0	1	System Timer
1	2	Keyboard Controller
2	-	Programmable Interrupt
3*	11	Communications Port (COM2)
4*	12	Communications Port (COM1)
5*	13	--
6	14	Floppy Disk Controller
7*	15	--
8	3	System CMOS/Real Time Clock
9*	4	ACPI Mode when used
10*	5	IRQ Holder for PCI Steering
11*	6	IRQ Holder for PCI Steering
12*	7	PS/2 Compatible Mouse Port
13	8	Numeric Data Processor
14*	9	Primary IDE Channel
15*	10	Secondary IDE Channel

* These IRQs are usually available for ISA or PCI devices.

2.6 Cable connections



- The bundled system cables are pre-connected before shipment. You do not need to disconnect these cables unless you are going to remove pre-installed components to install additional devices.
- Refer to the **Motherboard Information** chapter for detailed information on the connectors.

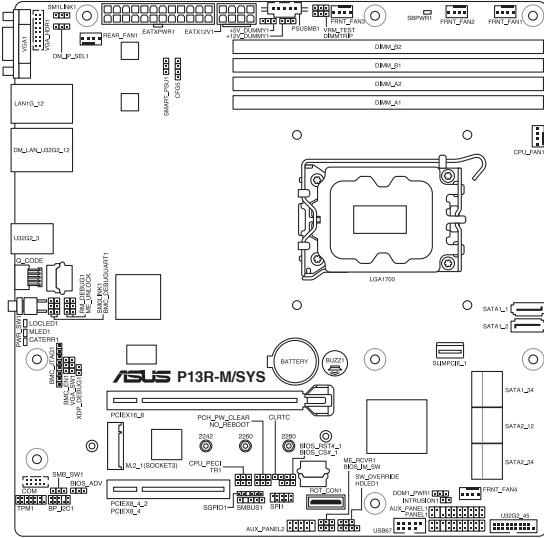

Pre-connected system cables

1. 24-pin EATXPWR1 power connector (connected to the power supply)
2. 8-pin EATX12V1 power connector (connected to the power supply)
3. Front panel connector (connected to the front I/O board)
4. Auxiliary panel connectors (connected to the front I/O board)
5. System fan connectors (connected to the system fans)
6. SATA connectors (connected to the backplane)

2.7 Backplane cabling

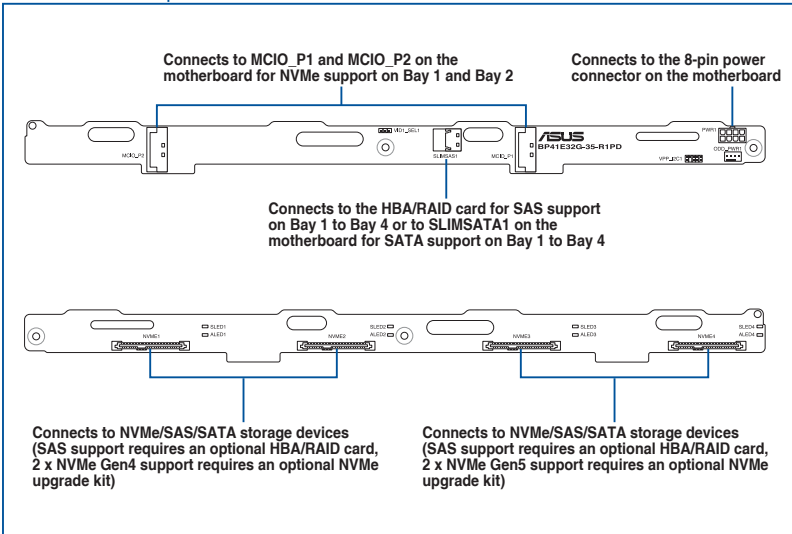
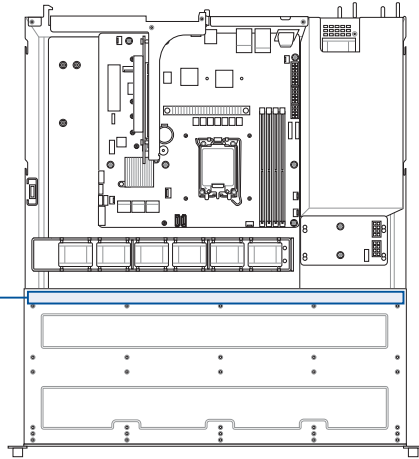

2.8 Redundant power supply units (on selected models)

1. Disconnect the power cable.
2. Hold the PSU handle and press the PSU latch, then pull the power supply unit out of the system chassis.

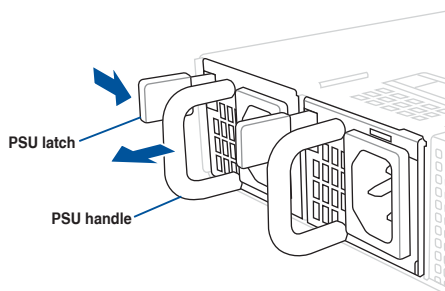

3. Insert the replacement power supply module into the chassis, then push it inwards until the latch locks into place.

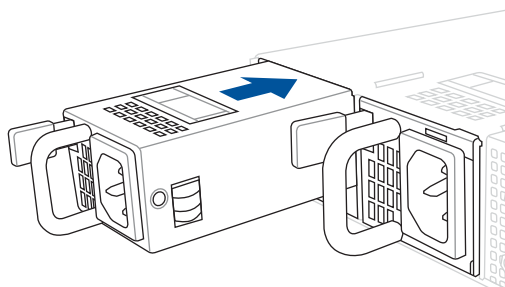

2.9 Motherboard

2.9.1 Removing the motherboard

To remove the system motherboard:

1. Disconnect the cables from the motherboard and remove any installed components on the motherboard.



Take a photo or make a note of which components are removed, which cables are disconnected, and which connectors the cables were connected to.

2. Remove the screws, then remove the motherboard.

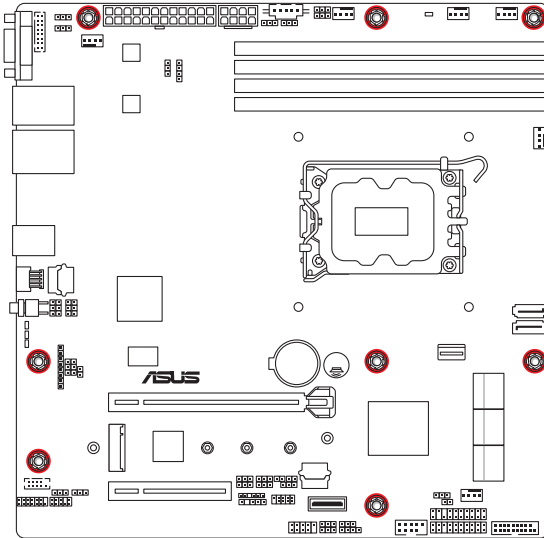

2.9.2 Installing the motherboard

To install the system motherboard:

1. Place the motherboard into the chassis and ensure the screw holes on the motherboard are aligned with the screw holes in the chassis, then secure the motherboard to the chassis using the screws removed previously.

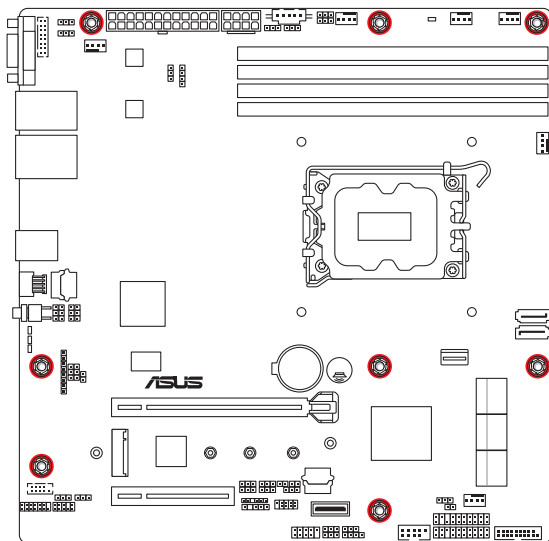

2. Reinstall any removed components and reconnect the cables to the motherboard.

2.10 CMOS battery

To replace a CMOS battery:

1. Locate and remove the CMOS battery.

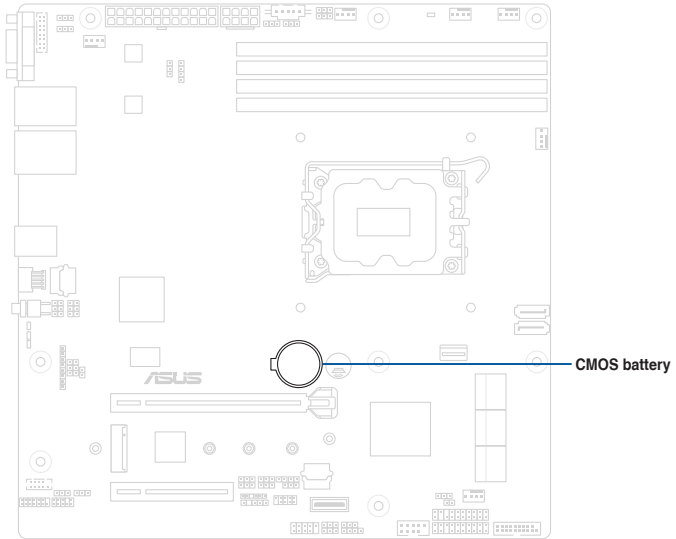

2. Place the replacement CMOS battery into the battery compartment.

2.11 Rail kit

This server system supports the rail kit options listed below. For more information on rail kit installation, refer to corresponding documentation on the ASUS support site or on the official product site for this server system.



-
- We strongly recommend that at least two able-bodied persons perform the installation of the rail kit.
 - We recommend the use of an appropriate lifting tool or device, if necessary.
-
- Friction rail kit

Motherboard Information

3

This chapter includes the motherboard layout and brief descriptions of the jumpers and internal connectors.

3.1 Motherboard layout

P13R-M/SYS

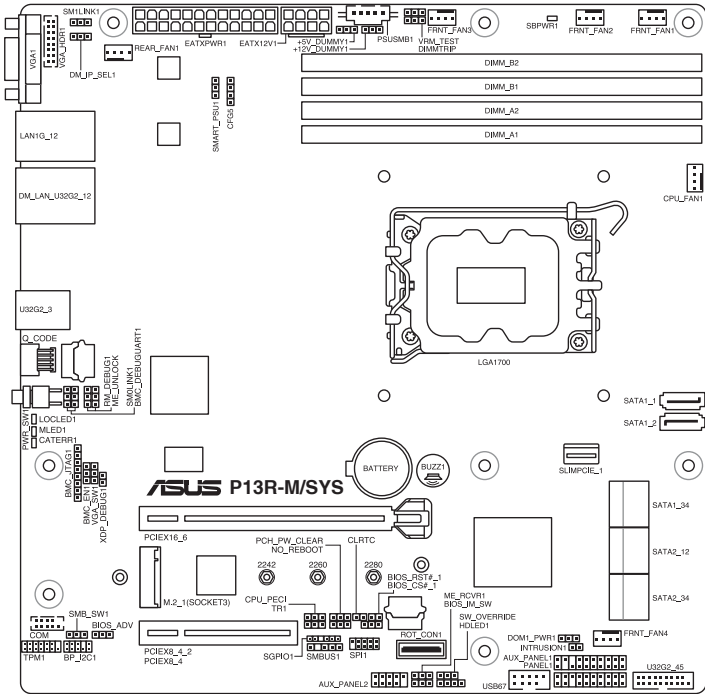

Layout contents

Jumpers		Page
1.	Clear RTC RAM (2-pin CLRTC)	3-4
2.	VGA controller setting (3-pin VGA_SW1)	3-5
3.	ME firmware force recovery setting (3-pin ME_RCVR1)	3-5
4.	Smart Ride Through (SmaRT) setting (3-pin SMART_PSU1)	3-6
5.	DMLAN setting (3-pin DM_IP_SEL1)	3-6
6.	SATADOM power setting (3-pin DOM1_PWR1)	3-7
7.	CPU PCIe configuration setting (4-pin CFG5)	3-7
8.	PCIe SMBus Switcher setting (3-pin SMB_SW1)	3-8

Onboard LEDs		Page
1.	Catastrophic error LED (CATERR1)	3-9
2.	Location LED (LOCLED1)	3-9
3.	Message LED (MLED1)	3-10

Internal connectors		Page
1.	SATA connectors (SATA1_1-2, SATA1_34, SATA2_12, SATA2_34)	3-11
2.	Hard disk activity LED connector (4-pin HDLED1)	3-11
3.	Serial General Purpose Input/Output connector (6-1 pin SGPIO1)	3-12
4.	USB 2.0 connectors (10-1 pin USB67)	3-12
5.	USB 3.2 Gen 1 connector (20-1 pin U32G2_45)	3-13
6.	Trusted Platform Module connector (14-1 pin TPM1)	3-13
7.	Fan connectors (4-pin CPU_FAN1, FRNT_FAN1-4, REAR_FAN1)	3-14
8.	Serial port connector (10-1 pin COM)	3-15
9.	Power Supply SMBus connector (5-pin PSUSMB1)	3-15
10.	ATX power connectors (24-pin EATXPWR1, 8-pin EATX12V1)	3-16
11.	System panel connector (20-1 pin PANEL1)	3-17
12.	Auxiliary panel connectors (20-2 pin AUX_PANEL1)	3-18
13.	Chassis intrusion connector (2-pin INTRUSION1)	3-19
14.	System Management Bus (SMBUS) connector (5-1 pin SMBUS1)	3-19

3.2 Jumpers



The motherboard illustration is for reference only. The motherboard layout and appearance may vary depending on the model, but the locations for these jumpers/LEDs/connectors remain the same.

1. Clear RTC RAM (2-pin CLRTC)

This jumper allows you to clear the CMOS memory system setup parameters by erasing the CMOS Real Time Clock (RTC) RAM data. The onboard button cell battery powers the RAM data in CMOS.

To erase the RTC RAM:

1. Turn OFF the computer and unplug the power cord.
2. Short-circuit pin 1-2 with a metal object or jumper cap for about 5-10 seconds.
3. Plug the power cord and turn ON the computer.
4. Hold down the key during the boot process and enter BIOS setup to re-enter data.



DO NOT short-circuit the pins except when clearing the RTC RAM. Short-circuiting or placing a jumper cap will cause system boot failure!



- If the steps above do not help, remove the onboard battery and short the two pins again to clear the CMOS RTC RAM data. After clearing the CMOS, reinstall the battery.
- Due to chipset behavior, AC power off is required to enable C.P.R. function. You must turn off and on the power supply or unplug and plug the power cord before rebooting the system.

P13R-M CLRTC

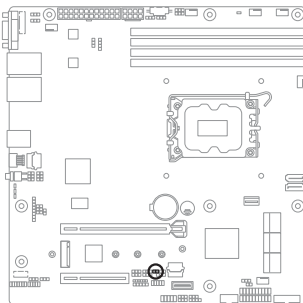

CLRTC

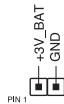

2. VGA controller setting (3-pin VGA_SW1)

This jumper allows you to enable or disable the onboard VGA controller. Set to pins 1–2 to activate the VGA feature.

P13R-M VGA_SW1

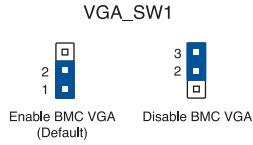
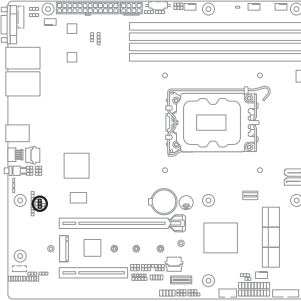

3. ME firmware force recovery setting (3-pin ME_RCVR1)

Set to pins 2-3 to force Intel® Management Engine (ME) to boot in recovery mode if the ME becomes corrupted.

P13R-M ME_RCVR1

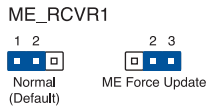
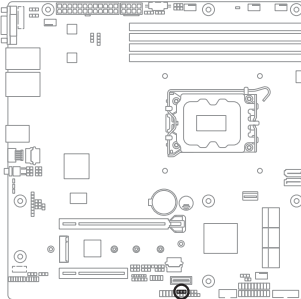

4. Smart Ride Through (Smart) setting (3-pin SMART_PSU1)

This jumper allows you to enable or disable the Smart Ride Through (SmaRT) function. This feature is disabled by default. Set to pins 1-2 to enable it. When enabled, SmaRT allows uninterrupted operation of the system during an AC loss event.

P13R-M SMART_PSU1

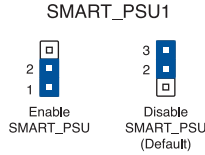
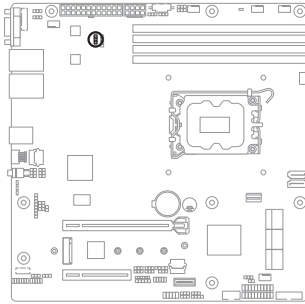

5. DMLAN setting (3-pin DM_IP_SEL1)

This jumper allows you to select the DMLAN setting. Set to pins 2-3 to force the DMLAN IP to static mode (IP=10.10.10.10, submask=255.255.255.0).

P13R-M DM_IP_SEL1

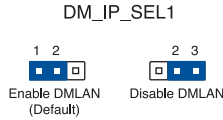
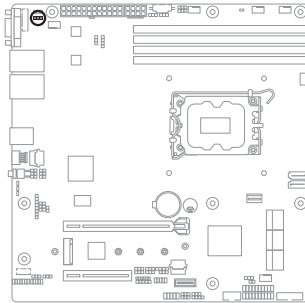

6. SATADOM power setting (3-pin DOM1_PWR1)

This jumper allows SATA5 to support SATADOM which do not need external power connections. Set to pins 2-3 to activate the SATA5 support feature.

P13R-M DOM1_PWR1

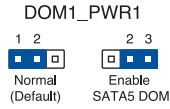
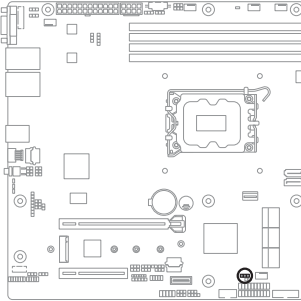

7. CPU PCIe configuration setting (4-pin CFG5)

These jumpers allow you to configure the speed at which PCIEX16_6 will run at.

P13R-M CFG5

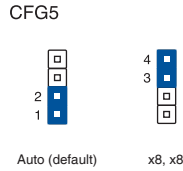
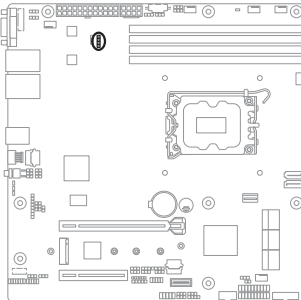

8. PCIe SMBus Switcher setting (3-pin SMB_SW1)

This jumper toggles whether the SMBUS signal comes from BMC or PCH.

P13R-M SMB_SW1

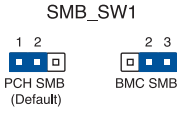
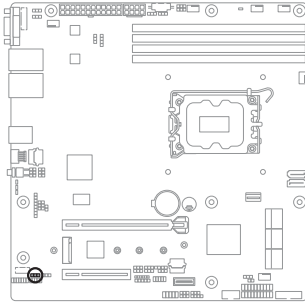

3.3 Onboard LEDs



The motherboard illustration is for reference only. The motherboard layout and appearance may vary depending on the model, but the locations for these jumpers/LEDs/connectors remain the same.

1. Catastrophic Error LED (CATERR1)

The catastrophic error LED indicates that the system has experienced a fatal or catastrophic error and cannot continue to operate.

P13R-M CATERR1

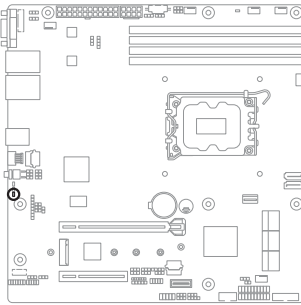

CATERR1



2. Location LED (LOCLE1)

This onboard LED lights up when the Location button on the server is pressed or when triggered by a system management software. The Location LED helps visually locate and quickly identify the server in error on a server rack.

P13R-M LOCLE1

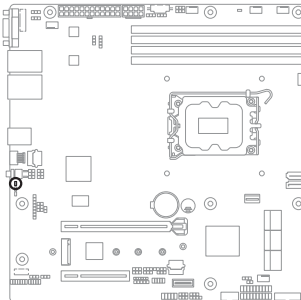

LOCLE1



3. Message LED (MLED1)

This onboard LED lights up to indicate that there is a temperature warning or a BMC event log is generated.

P13R-M MLED1

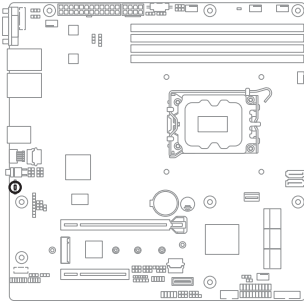

MLED1



3.4 Internal connectors





1. SATA connectors (SATA1_1-2; SATA1_34; SATA2_12; SATA2_34)

These connectors are for the Serial ATA signal cables for Serial ATA hard disk drives that allows up to 6Gb/s of data transfer rate.

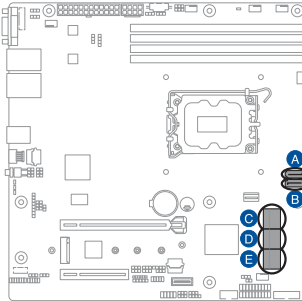
If you installed Serial ATA hard disk drives, you can create a RAID 0, RAID 1, RAID 10, or RAID 5 configuration.

P13R-M SATA connectors



- A SATA1_1 
- B SATA1_2 
- C SATA1_34 
- D SATA2_12 
- E SATA2_34 



The actual data transfer rate depends on the speed of Serial ATA hard disks installed.

2. Hard disk activity LED connector (4-pin HDLED1)

This LED connector is for the storage add-on card cable connected to the SATA or SAS add-on card. The read or write activities of any device connected to the SATA or SAS add-on card causes the front panel LED to light up.

P13R-M HDLED1

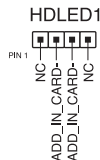
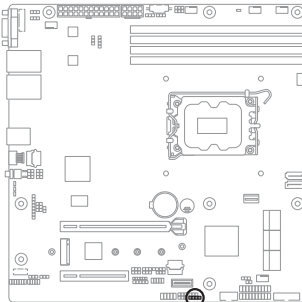

3. Serial General Purpose Input/Output connector (6-1 pin SGPIO1)

The SGPIO 1 connector is used for the Intel Rapid Storage Technology Enterprise SGPIO interface that controls the LED pattern generation, device information, and general purpose data.

P13R-M SGPIO1

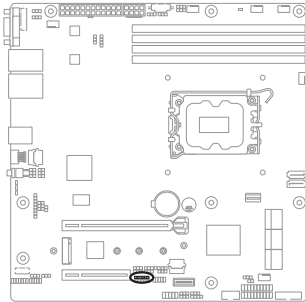

4. USB 2.0 connectors (10-1 pin USB67)

This connector allows you to connect a USB 2.0 module for additional USB 2.0 front or rear panel ports. This USB connector provides data transfer speeds of up to 480 Mb/s connection speed.

P13R-M USB67

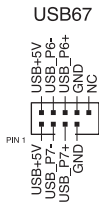
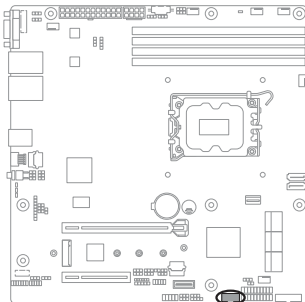

5. USB 3.2 Gen 1 connector (20-1 pin U32G2_45)

This connector allows you to connect a USB 3.2 Gen 1 module for additional USB 3.2 Gen 1 front or rear panel ports. The USB 3.2 Gen 1 connector provides data transfer speeds of up to 5 Gb/s.

P13R-M U32G2_45

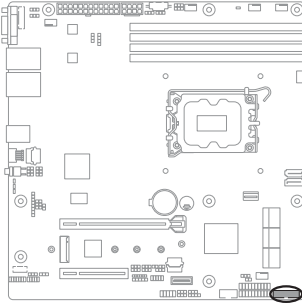

U32G2_45

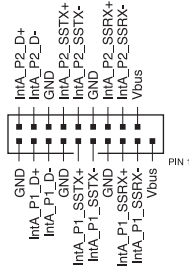

The USB 3.2 Gen 1 module is purchased separately.



The plugged USB 3.2 Gen 1 device may run on xHCI or EHCI mode depending on the operating system's setting.

6. Trusted Platform Module connector (14-1 pin TPM1)

This connector supports a Trusted Platform Module (TPM) system, which can securely store keys, digital certificates, passwords, and data. A TPM system also helps enhance network security, protects digital identities, and ensures platform integrity.

P13R-M TPM1

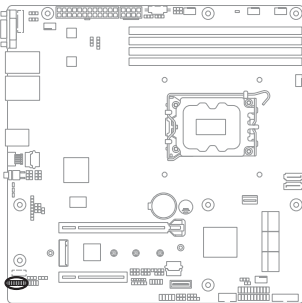

TPM1

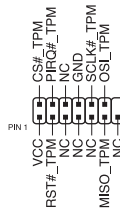

7. Fan connectors (4-pin CPU_FAN1, FRNT_FAN1-4, REAR_FAN1)

The fan connectors support cooling fans. Connect the fan cables to the fan connectors on the motherboard, ensuring that the black wire of each cable matches the ground pin of the connector.

P13R-M Fan connectors

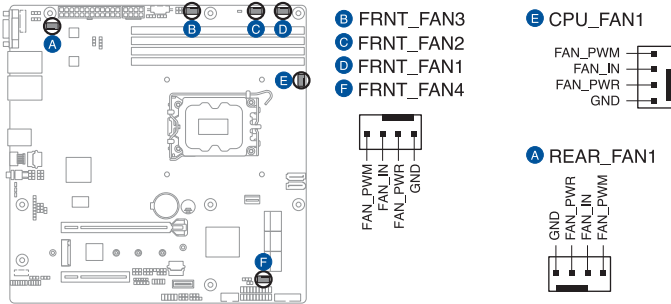

- DO NOT forget to connect the fan cables to the fan connectors. Insufficient air flow inside the system may damage the motherboard components.
- These are not jumpers! DO NOT place jumper caps on the fan connectors!
- All fans feature the ASUS Smart Fan technology.

8. Serial port connector (10-1 pin COM)

These connectors are for the serial (COM) ports. Connect the serial port module cable to the connector, then install the module to a slot opening at the back of the system chassis.

P13R-M COM

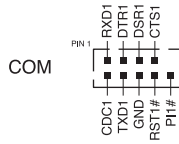
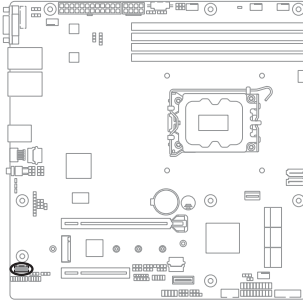

9. Power Supply SMBus connector (5-pin PSUSMB1)

This connector allows you to connect SMBus (System Management Bus) to the PSU (power supply unit) to read PSU information. Devices communicate with an SMBus host and/or other SMBus devices using the SMBus interface.

P13R-M PSUSMB1

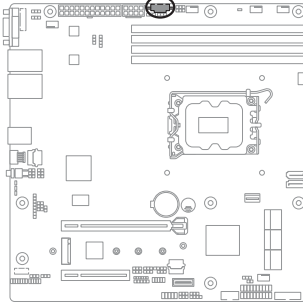

PSUSMB1

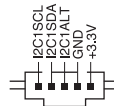

This connector functions only when you enable ASMB.



Power supply is required to meet PMBus specification and customized BMC FW may be needed. Please contact ASUS for additional information.

10. ATX power connectors (24-pin EATXPWR1, 8-pin EATX12V1)

These connectors are for the ATX power supply plugs. The power supply plugs are designed to fit these connectors in only one orientation. Find the proper orientation and push down firmly until the connectors completely fit.

P13R-M ATX power connectors

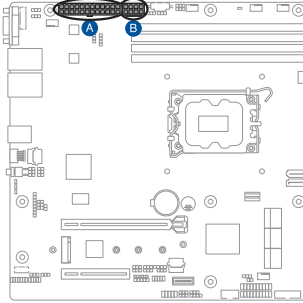

A EATXPWR1

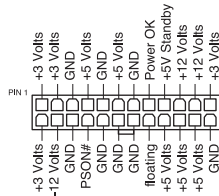

B EATX12V1

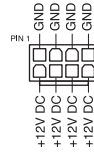

- DO NOT forget to connect the 24-pin and the 8-pin power plugs; otherwise, the system will not boot up.
- Use of a power supply unit (PSU) with a higher power output is recommended when configuring a system with more power-consuming devices. The system may become unstable or may not boot up if the power is inadequate.
- This motherboard supports ATX2.0 PSU or later version.
- Ensure that your PSU can provide at least the minimum power required by your system.

11. System panel connector (20-1 pin PANEL1)

This connector supports several chassis-mounted functions.

P13R-M PANEL1

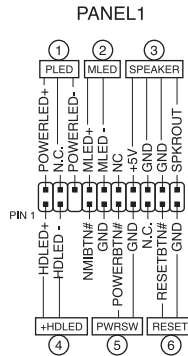
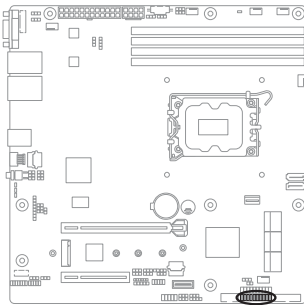

- **System power LED (3-pin PLED)**

This 3-pin connector is for the system power LED. Connect the chassis power LED cable to this connector. The system power LED lights up when you turn on the system power, and blinks when the system is in sleep mode.

- **Message LED (2-pin MLED)**

This 2-pin connector is for the message LED cable that connects to the front message LED. The message LED is controlled by Hardware monitor to indicate an abnormal event occurrence.

- **System warning speaker (4-pin SPEAKER)**

This 4-pin connector is for the chassis-mounted system warning speaker. The speaker allows you to hear system beeps and warnings.

- **Hard disk drive activity LED (2-pin +HDLED)**

This 2-pin connector is for the HDD Activity LED. Connect the HDD Activity LED cable to this connector. The IDE LED lights up or flashes when data is read from or written to the HDD.

- **Power button/soft-off button (2-pin PWRSW)**

This connector is for the system power button. Pressing the power button turns the system on or puts the system in sleep or soft-off mode depending on the BIOS settings. Pressing the power switch for more than four (4) seconds while the system is ON turns the system OFF.

- **Reset button (2-pin RESET)**

This 2-pin connector is for the chassis-mounted reset button for system reboot without turning off the system power.

12. Auxiliary panel connectors (20-2 pin AUX_PANEL1)

These connectors are for additional front panel features including front panel SMB, locator LED and switch, chassis intrusion, and LAN LEDs.

P13R-M AUX_PANEL1

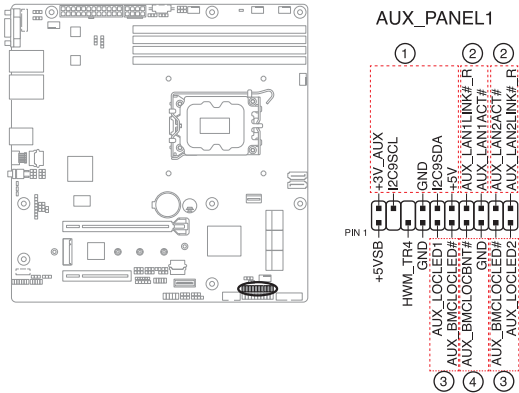

- **Front panel SMB (6-1 pin FPSMB)**
This 6-1 pin connector is for the front panel SMBus cable.
- **LAN activity LED (2-pin AUX_LAN1-2)**
This 2-pin connector is for the Gigabit LAN activity LEDs on the front panel.
- **Locator LED (2-pin AUX_LOCLEDD1-2)**
This 2-pin connector is for the locator LED1 and LED2 on the front panel. Connect the Locator LED cables to these 2-pin connector. The LEDs will light up when the Locator button is pressed.
- **Locator Button/Switch (2-pin AUX_BMCLOCBNT)**
This 2-pin connector is for the locator button on the front panel. This button queries the state of the system locator.

13. Chassis intrusion connector (2-pin INTRUSION1)

This connector is for a chassis-mounted intrusion detection sensor or switch. Connect one end of the chassis intrusion sensor or switch cable to this connector. The chassis intrusion sensor or switch sends a high-level signal to this connector when a chassis component is removed or replaced. The signal is then generated as a chassis intrusion event.

By default, the pin labeled “Chassis Signal” and “Ground” are shorted with a jumper cap. Remove the jumper caps only when you intend to use the chassis intrusion detection feature.

P13R-M INTRUSION1

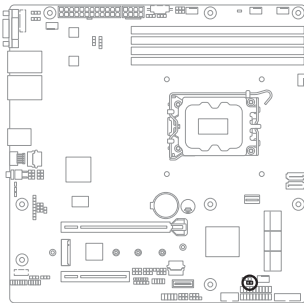

INTRUSION1



14. System Management Bus (SMBUS) connector (5-1 pin SMBUS1)

This connector controls the system and power management-related tasks. This connector processes the messages to and from devices rather than tripping the individual control lines.

P13R-M SMBUS1

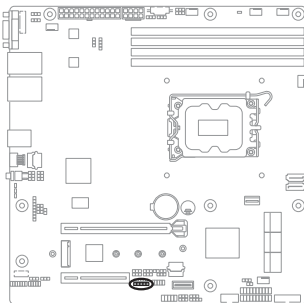

SMBUS1

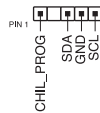

BIOS Setup

4

This chapter tells how to change the system settings through the BIOS Setup menus. Detailed descriptions of the BIOS parameters are also provided.

4.1 Managing and updating your BIOS

The following utilities allow you to manage and update the motherboard Basic Input/Output System (BIOS) setup:

1. **ASUS CrashFree BIOS 3**

To recover the BIOS using a bootable USB flash disk drive when the BIOS file fails or gets corrupted.

2. **ASUS EzFlash**

Updates the BIOS using a USB flash disk.

4.1.1 **ASUS CrashFree BIOS 3 utility**

The ASUS CrashFree BIOS 3 is an auto recovery tool that allows you to restore the BIOS file when it fails or gets corrupted during the updating process. You can update a corrupted BIOS file using a USB flash drive that contains the updated BIOS file.



Prepare a USB flash drive containing the updated motherboard BIOS before using this utility.

Recovering the BIOS from a USB flash drive

To recover the BIOS from a USB flash drive:

1. Insert the USB flash drive with the original or updated BIOS file to one USB port on the system.
2. The utility will automatically recover the BIOS. It resets the system when the BIOS recovery finished.



DO NOT shut down or reset the system while recovering the BIOS! Doing so would cause system boot failure!



The recovered BIOS may not be the latest BIOS version for this motherboard. Visit the ASUS website at www.asus.com to download the latest BIOS file.

4.1.2 ASUS EZ Flash Utility

The ASUS EZ Flash Utility feature allows you to update the BIOS without having to use a DOS-based utility.



Before you start using this utility, download the latest BIOS from the ASUS website at www.asus.com.

To update the BIOS using EZ Flash Utility:

1. Insert the USB flash disk that contains the latest BIOS file into the USB port.
2. Enter the BIOS setup program. Go to the **Tool** menu, then select **Start ASUS EZ Flash**. Press <Enter>.

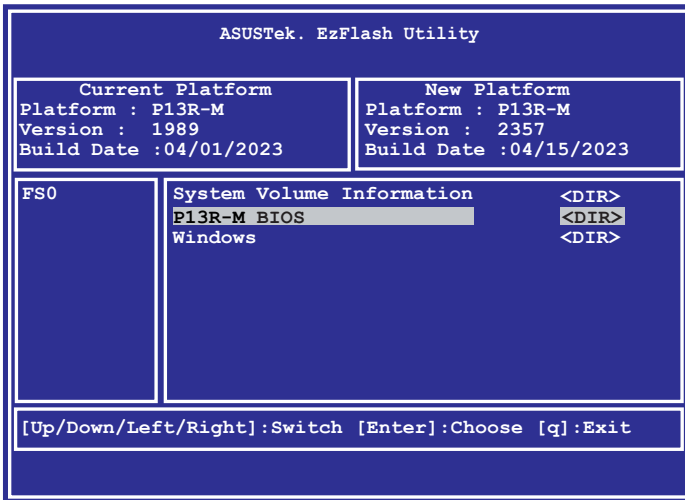

3. Press the Left/Right arrow keys to switch to the **Drive** field.
4. Press the Up/Down arrow keys to find the USB flash disk that contains the latest BIOS, then press <Enter>.
5. Press Left/Right arrow keys to switch to the **Folder Info** field.
6. Press the Up/Down arrow keys to find the BIOS file, then press <Enter> to perform the BIOS update process. Reboot the system when the update process is done.



- This function can support devices such as a USB flash disk with FAT 32/16 format and single partition only.
- DO NOT shut down or reset the system while updating the BIOS to prevent system boot failure!



Ensure to load the BIOS default settings to ensure system compatibility and stability. Press <F5> and select **Yes** to load the BIOS default settings.

4.2 BIOS setup program

This motherboard supports a programmable firmware chip that you can update using the provided utility described in the **Managing and updating your BIOS** section.

Use the BIOS Setup program when you are installing a motherboard, reconfiguring your system, or prompted to “Run Setup.” This section explains how to configure your system using this utility.

Even if you are not prompted to use the Setup program, you can change the configuration of your computer in the future. For example, you can enable the security password feature or change the power management settings. This requires you to reconfigure your system using the BIOS Setup program so that the computer can recognize these changes and record them in the CMOS RAM of the firmware chip.

The firmware chip on the motherboard stores the Setup utility. When you start up the computer, the system provides you with the opportunity to run this program. Press during the Power-On Self-Test (POST) to enter the Setup utility; otherwise, POST continues with its test routines.

If you wish to enter Setup after POST, restart the system by pressing <Ctrl>+<Alt>+<Delete>, or by pressing the reset button on the system chassis. You can also restart by turning the system off and then back on. Do this last option only if the first two failed.

The Setup program is designed to make it as easy to use as possible. Being a menu-driven program, it lets you scroll through the various sub-menus and make your selections from the available options using the navigation keys.



-
- The default BIOS settings for this motherboard apply for most conditions to ensure optimum performance. If the system becomes unstable after changing any BIOS settings, load the default settings to ensure system compatibility and stability. Press <F5> and select **Yes** to load the BIOS default settings.
 - The BIOS setup screens shown in this section are for reference purposes only, and may not exactly match what you see on your screen.
 - Visit the ASUS website (www.asus.com) to download the latest BIOS file for this motherboard.
-

4.2.1 BIOS menu screen

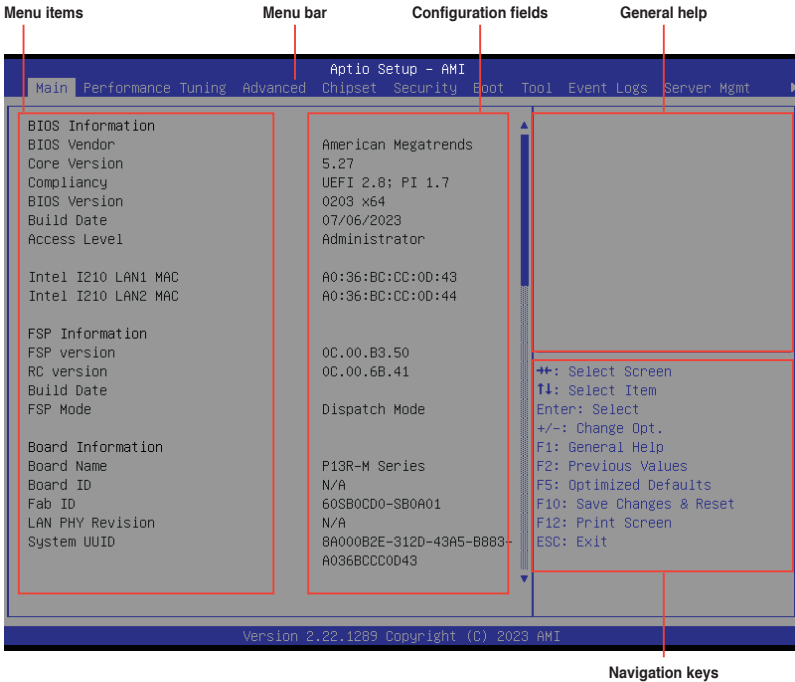

4.2.2 Menu bar

The menu bar on top of the screen has the following main items:

- Main** For changing the basic system configuration
- Advanced** For changing the advanced system settings
- Security** For changing the security settings
- Boot** For changing the system boot configuration
- Tool** For configuring options for special functions
- Event Logs** For changing the event log settings
- Server Mgmt** For changing the Server Mgmt settings
- Exit** For selecting the exit options

To select an item on the menu bar, press the right or left arrow key on the keyboard until the desired item is highlighted.

Menu items

The highlighted item on the menu bar displays the specific items for that menu. For example, selecting **Main** shows the Main menu items.

The other items (such as **Advanced**) on the menu bar have their respective menu items.

Submenu items

A solid triangle before each item on any menu screen means that the item has a submenu. To display the submenu, select the item then press <Enter>.

Navigation keys

At the bottom right corner of a menu screen are the navigation keys for the BIOS setup program. Use the navigation keys to select items in the menu and change the settings.

General help

At the top right corner of the menu screen is a brief description of the selected item.

Configuration fields

These fields show the values for the menu items. If an item is user-configurable, you can change the value of the field opposite the item. You cannot select an item that is not user-configurable.

A configurable field is enclosed in brackets, and is highlighted when selected. To change the value of a field, select it and press <Enter> to display a list of options.

Pop-up window

Select a menu item and press <Enter> to display a pop-up window with the configuration options for that item.

Scroll bar

A scroll bar appears on the right side of a menu screen when there are items that do not fit on the screen. Press the Up/Down arrow keys or <Page Up> / <Page Down> keys to display the other items on the screen.

4.3 Main menu

When you enter the BIOS Setup program, the Main menu screen appears. The Main menu provides you an overview of the basic system information, and allows you to set the system date, time, and language.

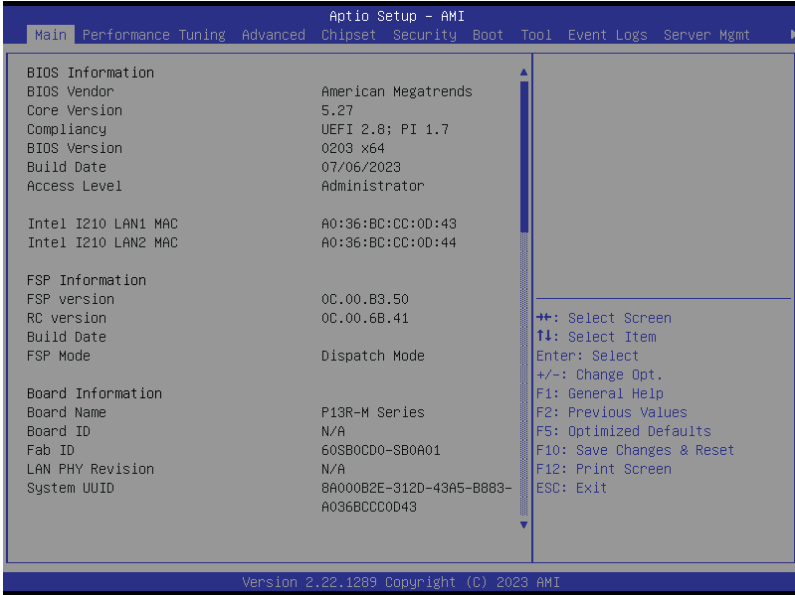

System Language

Allows you to set the system language.

System Date [MM/DD/YYYY]

Allows you to set the system date.

System Time [HH:MM:SS]

Allows you to set the system time.

4.4 Performance Tuning menu

The Performance Tuning menu items allow you to change performance related settings for different scenarios.

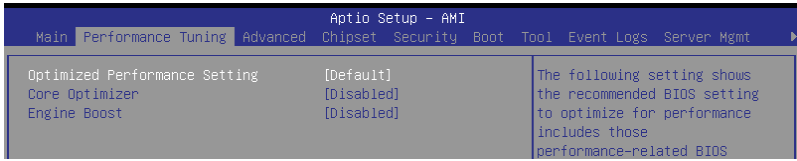

Optimized Performance Setting [Default]

Allows you to select performance settings for different scenarios.

[Default] Default settings.

[By Benchmark] Optimize for different kinds of benchmarks. Select this option, then select a benchmark type from the >> list.



This function will reset some BIOS settings that you have changed back to their default values. Please check your BIOS settings again.



The following item appears only when **Power Balancer** is set to **[Disabled]**, or if Optimized Performance Setting is set to **[Default]** or **[By Benchmark]**.

Core Optimizer [Disabled]

Allows you to keep the processor operating at the turbo highest frequency for the maximum performance.

Configuration options: [Disabled] [Enabled] [Manual]



The following item appears only when you set **Core Optimizer** to **[Manual]**.

CPU Max frequency [XXXX]

The default value for this option will be the maximum supported frequency of the CPU installed and may vary between different CPUs.



The following item appears only when **Optimized Performance Setting** is set to **[Default]** or **[By Benchmark]**.

Engine Boost [Disabled]

Enable this item to boost the CPU's frequency. Recommended operation at an ambient temperature of 25°C or below for optimized performance.

Configuration options: [Disabled] [Level1] [Level2] [Level3(Max)]



Operate with an ambient temperature of 25°C or lower for optimized performance.

4.5 Advanced menu

The Advanced menu items allow you to change the settings for the CPU and other system devices.



Take caution when changing the settings of the Advanced menu items. Incorrect field values can cause the system to malfunction.

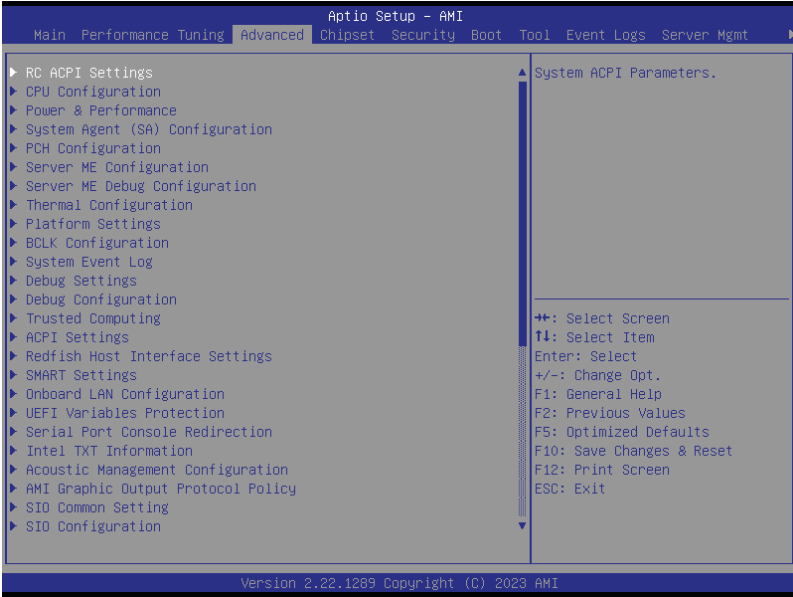

4.5.1 RC ACPI Settings

Advanced		Aptio Setup - AMI
RC ACPI Settings		PTID Support will be loaded if enabled.
PTID Support	[Enabled]	
PECI Access Method	[Direct I/O]	
PCI Express Native Power Management	[Enabled]	
Native ASPM	[Auto]	
BDAT ACPI Table Support	[Disabled]	
ACPI Debug	[Disabled]	
PCI Delay Optimization	[Disabled]	
MSI enabled	[Enabled]	

PTID Support [Enabled]

Configuration options: [Disabled] [Enabled]

PECI Access Method [Direct I/O]

Configuration options: [Direct I/O] [ACPI]

PTID Support [Enabled]

Configuration options: [Disabled] [Enabled]

PCI Express Native Power Management [Enabled]

Configuration options: [Disabled] [Enabled]



The following items are only available when **PCI Express Native Power Management** is set to **[Enabled]**.

Native ASPM [Auto]

Configuration options: [Auto] [Enabled] [Disabled]

BDAT ACPI Table Support [Disabled]

Configuration options: [Disabled] [Enabled]

ACPI Debug [Disabled]

Configuration options: [Disabled] [Enabled]

PCI Delay Optimization [Disabled]

Configuration options: [Disabled] [Enabled]

MSI Enabled [Enabled]

Configuration options: [Disabled] [Enabled]

4.5.2 CPU Configuration

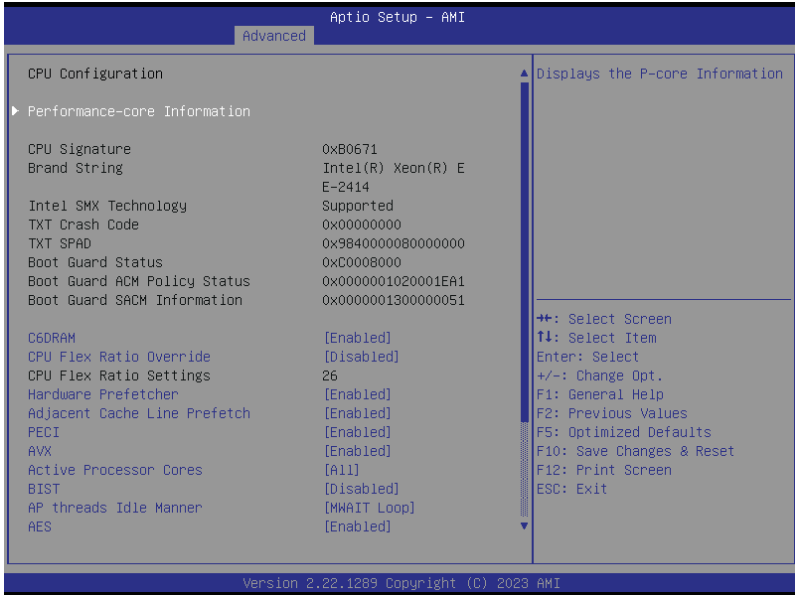

Performance-core Information

Allows you to view performance-core information.

C6DRAM [Enabled]

Configuration options: [Disabled] [Enabled]

CPU Flex Ratio Override [Disabled]

Configuration options: [Disabled] [Enabled]



The following items are only available when **CPU Flex Ratio Override** is set to **[Enabled]**.

CPU Flex Ratio Settings [26]

Allows you to set the CPU Flex Ratio.

Hardware Prefetcher [Enabled]

Configuration options: [Disabled] [Enabled]

Adjacent Cache Line Prefetch [Enabled]

Configuration options: [Disabled] [Enabled]

PECI [Enabled]

Configuration options: [Disabled] [Enabled]

AVX [Enabled]

Configuration options: [Disabled] [Enabled]

Active Processor Cores [All]

Configuration options: [All] [1] [2] [3]

BIST [Disabled]

Configuration options: [Disabled] [Enabled]

AP Threads Idle Manner [MWAIT Loop]

Configuration options: [HALT Loop] [MWAIT Loop] [RUN Loop]

AES [Enabled]

Configuration options: [Disabled] [Enabled]

Machine Check [Enabled]

Configuration options: [Disabled] [Enabled]

MonitorMWait [Enabled]

Configuration options: [Disabled] [Enabled]

Intel Trusted Execution Technology [Disabled]

Configuration options: [Disabled] [Enabled]



The following items are only available when **Intel Trusted Execution Technology** is set to **[Enabled]**.

Alias Check Request [Disabled]

Configuration options: [Disabled] [Enabled]

DPR Memory Size (MB)

Allows you to set the DPR memory size in MB.

CPU SMM Enhancement

Allows you to configure CPU SMM Enhancement options.

Total Memory Encryption [Enabled]

Configuration options: [Disabled] [Enabled]

4.5.3 Power & Performance



CPU - Power Management Control

Boot performance mode [Turbo Performance]

Configuration options: [Max Battery] [Max Non-Turbo Performance] [Turbo Performance]

Intel(R) SpeedStep(tm) [Enabled]

Configuration options: [Disabled] [Enabled]

Race To Halt (RTH) [Enabled]

Configuration options: [Disabled] [Enabled]

Intel(R) Speed Shift Technology [Native Mode]

Configuration options: [Disabled] [Native Mode] [Out of Band Mode]



The following items are only available when Intel(R) Speed Shift Technology is set to [Disabled] or [Native Mode].

Per Core P State OS control mode [Enabled]

Configuration options: [Disabled] [Enabled]

HwP Autonomous Per Core P State [Enabled]

Configuration options: [Disabled] [Enabled]

HwP Autonomous EPP Grouping [Enabled]

Configuration options: [Disabled] [Enabled]

EPB Override Over PECC [Enabled]

Configuration options: [Disabled] [Enabled]

HwP Fast MSR Support [Disabled]

Configuration options: [Disabled] [Enabled]

HwP Lock [Enabled]

Configuration options: [Disabled] [Enabled]

HDC Control [Enabled]

Configuration options: [Disabled] [Enabled]

Turbo Mode [Enabled]

Configuration options: [Disabled] [Enabled]

C-States [Enabled]

Configuration options: [Disabled] [Enabled]

View/Configure Turbo Options

Allows you to configure Turbo options.

CPU VR Settings

Allows you to configure CPU VR options.

Platform PL1 Enable [Disabled]

Configuration options: [Disabled] [Enabled]



The following items are only available when **Platform PL1 Enable** is set to **[Enabled]**.

Platform PL1 Power [0]

Allows you to set the Platform PL1 Power in milliwatts.

Platform PL1 Time Window [0]

Configuration options: [0-128]

Platform PL2 Enable [Disabled]

Configuration options: [Disabled] [Enabled]



The following items are only available when **Platform PL2 Enable** is set to **[Enabled]**.

Platform PL1 Power [0]

Allows you to set the Platform PL2 Power in milliwatts.

Power Limit 4 Override [Disabled]

Configuration options: [Disabled] [Enabled]



The following items are only available when **Power Limit 4 Override** is set to **[Enabled]**.

Power Limit 4 [0]

Allows you to set the Power Limit 4 in milliwatts.

Power Limit 4 Lock [Disabled]

Configuration options: [Disabled] [Enabled]

C-States [Enabled]

Configuration options: [Disabled] [Enabled]



The following items are only available when **C-States** is set to **[Enabled]**.

Enhanced C-States [Enabled]

Configuration options: [Disabled] [Enabled]

C-State Auto Demotion [C1]

Configuration options: [Disabled] [C1]

C-State Un-demotion [C1]

Configuration options: [Disabled] [C1]

Package C-State Demotion [Enabled]

Configuration options: [Disabled] [Enabled]

Package C-State Un-demotion [Enabled]

Configuration options: [Disabled] [Enabled]

C-State Pre-Wake [Enabled]

Configuration options: [Disabled] [Enabled]

IO MWAIT Redirection [Disabled]

Configuration options: [Disabled] [Enabled]

Package C-state Limit [Auto]

Configuration options: [C0/C1] [C2] [C3] [C6] [C7] [C7S] [C8] [C9] [C10]
[CPU Default] [Auto]

C6/C7 Short Latency Control (MSR 0x60B)

Time Limit [1024 ns]

Configuration options: [1-33554432ns]

Latency [0]

Allows you to set the C6/C7 Short Latency Control (MSR 0x60B) latency.

C6/C7 Short Latency Control (MSR 0x60C)

Time Limit [1024 ns]

Configuration options: [1-33554432ns]

Latency [0]

Allows you to set the C6/C7 Short Latency Control (MSR 0x60B) latency.

Thermal Monitor [Enabled]

Configuration options: [Disabled] [Enabled]

Interrupt Redirection Mode Selection [Fixed Priority]

Configuration options: [Fixed Priority] [Round robin] [Hash vector] [No change]

Timed MWAIT [Disabled]

Configuration options: [Disabled] [Enabled]

Custom P-state Table

Allows you to configure Custom P-state Table options.

Energy Performance Gain [Disabled]

Configuration options: [Disabled] [Enabled]



The following items are only available when **Energy Performance Gain** is set to **[Enabled]**.

EPG DIMM Idd3N [26]

Allows you to set the EPG DIMM Idd3N in milliwatts.

EPG DIMM Idd3P [11]

Allows you to set the EPG DIMM Idd3P in milliwatts.

Power Limit 3 Settings

Allows you to configure Power Limit 3 options.

CPU Lock Configuration

Allows you to configure CPU Lock options.

GT - Power Management Control

RC6 (Render Standby) [Enabled]

Configuration options: [Disabled] [Enabled]

Maximum GT Frequency [Default Max Frequency]

Configuration options: [Default Max Frequency] [100-1200MHz]

Disable Turbo GT Frequency [Disabled]

Configuration options: [Disabled] [Enabled]

4.5.4 System Agent (SA) Configuration

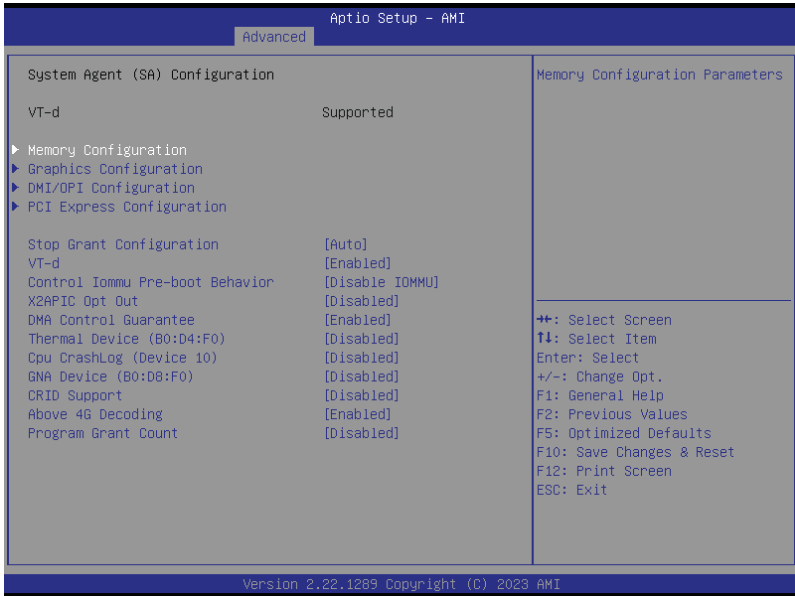

Memory Configuration

Allows you to configure Memory options.

Graphics Configuration

Allows you to configure Graphics options.

DMI/OPI Configuration

Allows you to configure DMI/OPI options.

PCI Express Configuration

Allows you to configure PCI Express options.

Stop Grant Configuration [Auto]

Configuration options: [Auto] [Manual]



The following items are only available when **Stop Grant Configuration** is set to **[Manual]**.

Number of Stop Grant Cycles [1]

Allows you to set the number of stop grant cycles.

VT-d [Enabled]

Configuration options: [Disabled] [Enabled]



The following items are only available when **VT-d** is set to **[Enabled]**.

Control IOMMU Pre-boot Behavior [Disable IOMMU]

Configuration options: [Disable IOMMU] [Enable IOMMU during boot]

X2APIC Opt Out [Disabled]

Configuration options: [Disabled] [Enabled]

DMA Control Guarantee [Enabled]

Configuration options: [Disabled] [Enabled]

Thermal Device (B0:D4:F0) [Disabled]

Configuration options: [Disabled] [Enabled]

CPU Crash Log (Device 10) [Disabled]

Configuration options: [Disabled] [Enabled]

GNA Device (B0:D8:F0) [Disabled]

Configuration options: [Disabled] [Enabled]

CRID Support [Disabled]

Configuration options: [Disabled] [Enabled]

Above 4G Decoding [Enabled]

Configuration options: [Disabled] [Enabled]

Program Grant Count [Disabled]

Configuration options: [Disabled] [Enabled]

4.5.5 PCH Configuration

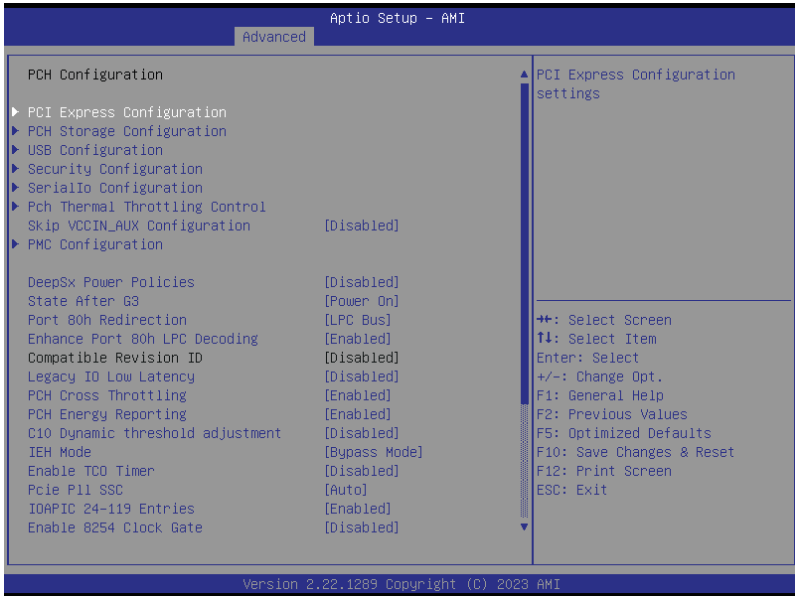

PCI Express Configuration

Allows you to configure PCI Express options.

PCH Storage Configuration

Allows you to configure PCH Storage options.

USB Configuration

Allows you to configure USB options.

Security Configuration

Allows you to configure Security options.

Serial IO Configuration

Allows you to configure Serial IO options.

PCH Thermal Throttling Control

Allows you to configure PCH Thermal Throttling Control options.

Skip VCCIN_AUX Configuration [Disabled]

Configuration options: [Disabled] [Enabled]

PMC Configuration

Allows you to configure PMC options.

DeepSx Power Policies [Disabled]

Configuration options: [Disabled] [Enabled in S4-S5] [Enabled in S5]

State After G3 [Power On]

Configuration options: [Power On] [Power Off]

Port 80h Redirection [LPC Bus]

Configuration options: [LPC Bus] [PCIe Bus]



The following items are only available when **Port 80h Redirection** is set to **[LPC Bus]**.

Enhance Port 80h LPC Decoding [Enabled]

Configuration options: [Disabled] [Enabled]

Legacy IO Low Latency [Disabled]

Configuration options: [Disabled] [Enabled]

PCH Cross Throttling [Enabled]

Configuration options: [Disabled] [Enabled]

PCH Energy Reporting [Enabled]

Configuration options: [Disabled] [Enabled]

C10 Dynamic Threshold Adjustment [Disabled]

Configuration options: [Disabled] [Enabled]

IEH Mode [Bypass Mode]

Configuration options: [Bypass Mode] [Enabled]

Enable TCO Timer [Disabled]

Configuration options: [Disabled] [Enabled]

PCIe P11 SSC [Auto]

Configuration options: [Disabled] [Auto] [0.0-2.0%]

IOAPIC 24-119 Entries [Enabled]

Configuration options: [Disabled] [Enabled]

Enable 8254 Clock Gate [Disabled]

Configuration options: [Disabled] [Enabled] [Enabled In Runtime and S3 Resume]

Lock PCH Sideband Access [Enabled]

Configuration options: [Disabled] [Enabled]

Flash Protection Range Registers (FPRR) [Enabled]

Configuration options: [Disabled] [Enabled]

SPD Write Disable [TRUE]

Configuration options: [TRUE] [FALSE]

LGMR [Disabled]

Configuration options: [Disabled] [Enabled]

HOST_C10 Reporting to Target [Disabled]

Configuration options: [Disabled] [Enabled]

OS IDLE Mode [Disabled]

Configuration options: [Disabled] [Enabled]

S0ix Auto Demotion [Disabled]

Configuration options: [Disabled] [Enabled]

Extended BIOS Range Decode [Disabled]

Configuration options: [Disabled] [Enabled]

4.5.6 Server ME Configuration

Displays the Server ME Technology parameters on your system. Scroll using <Page Up> / <Page Down> keys to see more items.

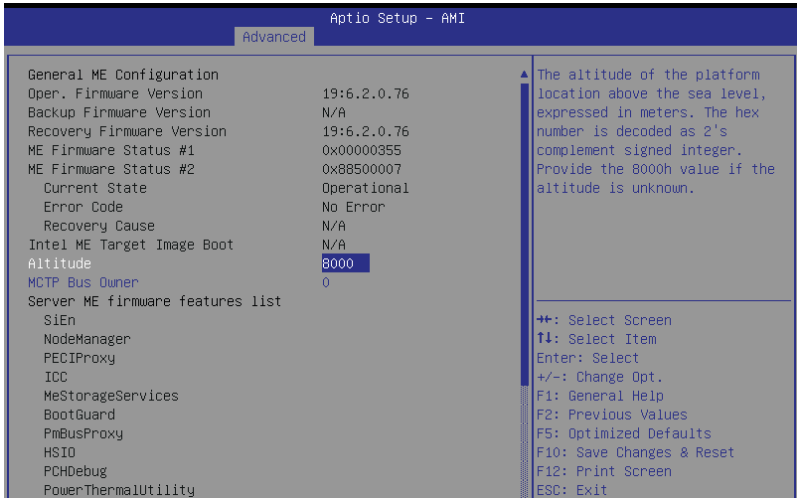

Altitude [8000]

Allows you to set the altitude of the platform location above the sea level, expressed in meters. The hex number is decoded as 2's complement signed integer. Provide the 8000h value if the altitude is unknown.

MCTP Bus Owner [0]

Allows you to enter the MCTP bus owner location on PCIe: [15:8] bus, [7:3] device, [2:0] function. If all zeros, sending bus owner will be disabled.

PSU #1-4

Allows you to enter the PMBus address (7-bit) that will be used to retrieve the status of the PSU. Set to 0 to disable the query..

4.5.7 Server ME Debug Configuration



Server ME General Configuration

Allows you to configure general Server ME options.

NM Configuration

Allows you to configure NM options.

ME UEFI FW Health Status

Allows you to view the ME UEFI FW health status.

4.5.8 Thermal Configuration

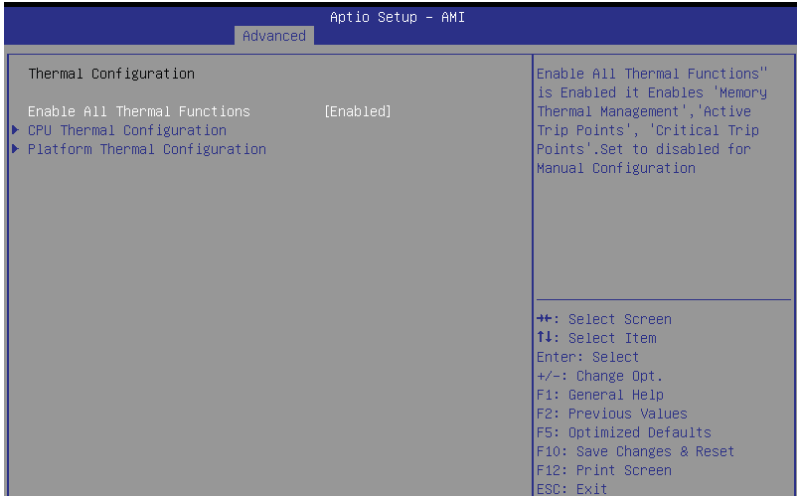

Enable All Thermal Functions [Enabled]

Configuration options: [Disabled] [Enable]

CPU Thermal Configuration

Allows you to configure CPU Thermal options.

Platform Thermal Configuration

Allows you to configure Platform Thermal options.

4.5.9 Platform Settings

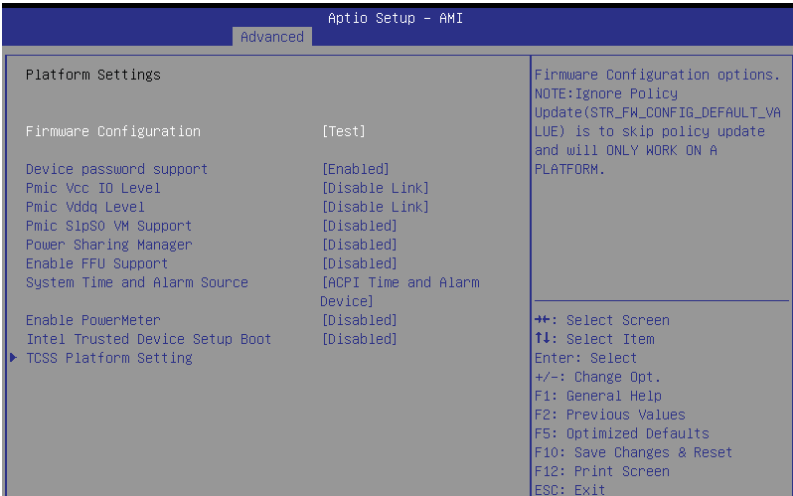

Firmware Configuration [Test]

Configuration options: [Test] [Ignore Policy Update] [Production]

Device Password Support [Enabled]

Configuration options: [Disabled] [Enabled]

Pmic Vcc IO Level [Disable Link]

Configuration options: [Disable Link] [1.05-0.950V]

Pmic Vddq Level [Disable Link]

Configuration options: [Disable Link] [0-7]

Pmic SlpS0 VM Support [Disabled]

Configuration options: [Disabled] [Enabled]

Power Sharing Manager [Disabled]

Configuration options: [Disabled] [Enabled]



The following items are only available when **Power Sharing Manager** is set to **[Enabled]**.

Domain Type SPLC 1 [9]

Allows you to set the domain type.

Default Power Limit 1 SPLC [4,000]

Allows you to set the default power limit.

Default Time Window 1 SPLC [30,000]

Allows you to set the default time window.

Domain Type DPLC 1 [9]

Allows you to set the domain type.

Domain Preference DPLC 1 [9]

Allows you to set the domain preference.

Power Limit Index 1 DPLC [0]

Allows you to set the power limit index.

Default Power Limit 1 DPLC [1,200]

Allows you to set the default power limit.

Default Time Window 1 DPLC [30,000]

Allows you to set the default time window.

Minimum Power Limit 1 DPLC [1,200]

Allows you to set the minimum power limit.

Maximum Power Limit 1 DPLC [1,200]

Allows you to set the maximum power limit.

Maximum Time Window 1 DPLC [1,000]

Allows you to set the maximum time window.

Enable FFU Support [Disabled]

Configuration options: [Disabled] [Enabled]

System Time and Alarm Source [ACPI Time and Alarm Device]

Configuration options: [ACPI Time and Alarm Device] [Legacy RTC]

Enable PowerMeter [Disabled]

Configuration options: [Disabled] [Enabled]

Intel Trusted Device Setup Boot [Disabled]

Configuration options: [Disabled] [Enabled]

TCSS Platform Setting

Allows you to configure TCSS Platform options.

4.5.10 BCLK Configuration

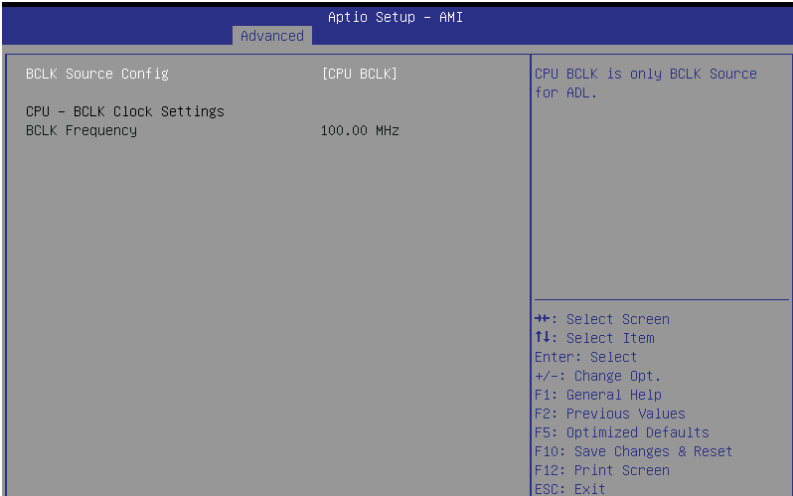

BCLK Source Config [CPU BCLK]

Configuration options: [CPU BCLK]

4.5.11 System Event Log

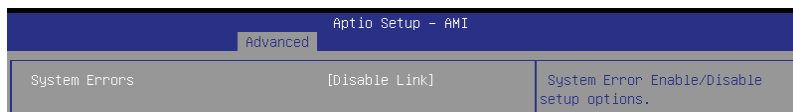

System Errors [Enabled]

Configuration options: [Disable Link] [Enabled]



The following items are only available when **System Errors** is set to **[Enabled]**.

Whea Driver Support [Enabled]

Configuration options: [Disabled] [Enabled]



The following items are only available when **Whea Driver Support** is set to **[Enabled]**.

Whea FFM Logging [Enabled]

Configuration options: [Disable Link] [Enabled]

WHEA/UEFI Record Format [UEFI 2.2]

Configuration options: [UEFI 2.2] [UEFI 2.3.1]

Memory Error Enabling

Allows you to configure Memory Error Enabling options.

PCH Error Enable [No]

Configuration options: [No] [Yes]



The following items are only available when **PCH Error Enable** is set to **[Yes]**.

PCI/PCI Error Enabling

Allows you to configure PCI/PCI Error Enabling options.

4.5.12 Debug Settings

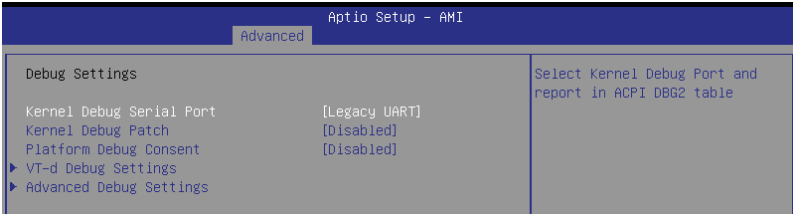

Kernel Debug Serial Port [Legacy UART]

Configuration options: [Legacy UART] [SERIALIO UART2]



The following items are only available when **Kernel Debug Serial Port** is set to [SERIALIO UART2].

Serial IO UART Debug Power Gating [Disabled]

Configuration options: [Disabled] [Enabled]

Kernel Debug Patch [Disabled]

Configuration options: [Disabled] [Enabled]

Platform Debug Consent [Disabled]

Configuration options: [Disabled] [Enabled (All Probes+TraceHub)] [Enabled (Low Power)] [Manual]

VT-d Debug Settings

Allows you to configure VT-d Debug options.

Advanced Debug Settings

Allows you to configure Advanced Debug options.

4.5.13 Debug Configuration

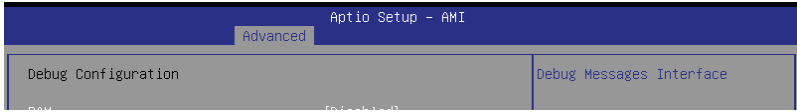

RAM [Disabled]

Configuration options: [Disabled] [Enabled]

Legacy UART [Enabled]

Configuration options: [Disabled] [Enabled]

USB3 [Disabled]

Configuration options: [Disabled] [Enabled]

Serial IO UART [Disabled]

Configuration options: [Disabled] [Enabled]

Trace Hub [Disabled]

Configuration options: [Disabled] [Enabled]

MRC Serial Debug Messages [Disabled]

Configuration options: [Disabled] [Error Only] [Error & Warnings] [Load, Error, Warnings & Info] [Load, Error, Warnings, Info & Event] [Load, Error, Warnings, Info & Verbose]

Serial Debug Messages [Load, Error, Warnings & Info]

Configuration options: [Disabled] [Error Only] [Error & Warnings] [Load, Error, Warnings & Info] [Load, Error, Warnings, Info & Event] [Load, Error, Warnings, Info & Verbose]

Serial Debug Message Baud Rate [115200]

Configuration options: [9600-115200]



The following items are only available when **Serial IO UART** is set to **[Enabled]**.

Controller Number [Serial IO UART 2]

Configuration options: [Serial IO UART 0-2]

Baud Rate [115200]

Configuration options: [9600-6000000]

Stop Bits [1]

Configuration options: [Default] [1-2]

Parity Bits [None]

Configuration options: [Default] [None] [Even] [Odd]

Flow Control [Disabled]

Configuration options: [Disabled] [Enabled]

Word Length [8 BITS]

Configuration options: [5-8 BITS]

4.5.14 Trusted Computing

Advanced		Aptio Setup - AMI
Configuration		
Security Device Support	[Enabled]	Enables or Disables BIOS support for security device. O.S. will not show Security Device. TCG EFI protocol and INT1A interface will not be available.
NO Security Device Found		

Security Device Support [Enabled]

Configuration options: [Disabled] [Enabled]

4.5.15 ACPI Settings

Advanced		Aptio Setup - AMI
ACPI Settings		
Enable ACPI Auto Configuration	[Disabled]	Enables or Disables BIOS ACPI Auto Configuration.

Enable ACPI Auto Configuration [Disabled]

Configuration options: [Disabled] [Enabled]

4.5.16 Redfish Host Interface Settings

Advanced		Aptio Setup - AMI
Redfish Host Interface Settings		Enable/Disable AMI Redfish
Redfish	[Enabled]	

Redfish [Enabled]

Allows you to enable or disable Redfish.
Configuration options: [Disabled] [Enabled]



The following items are only available when **Redfish** is set to **[Enabled]**.

Authentication mode [Basic Authentication]

Configuration options: [Basic Authentication] [Session Authentication]

IP address

Enter the IP address.

IP Mask address

Enter the IP Mask address.

IP Port

Enter the IP Port.

4.5.17 SMART Settings

Advanced		Aptio Setup - AMI
SMART Settings		
SMART Self Test	[Disabled]	The S.M.A.R.T. (self-monitoring, analysis and reporting technology) is a monitor system. Enable this item to show a warning message during the POST (power-on self test).

SMART Self Test [Disabled]

Configuration options: [Disabled] [Enabled]

4.5.18 Onboard LAN Configuration

P13R-M

Aptio Setup - AMI	
Advanced	
▶ Onboard I210 LAN Configuration	Onboard I210 LAN Enable/Disable

Onboard I210 LAN Configuration

Intel I210 LAN1-2

LAN Enable [Enabled]

Configuration options: [Disabled] [Enabled]

P13R-M/10G-2T

Aptio Setup - AMI	
Advanced	
▶ Onboard X710 LAN Configuration	Onboard X710 LAN Enable/Disable

Onboard X710 LAN Configuration

Intel X710 LAN1-2

LAN Enable [Enabled]

Configuration options: [Disabled] [Enabled]

4.5.19 UEFI Variables Protection

Aptio Setup - AMI	
Advanced	
Password protection of Runtime Variables [Enable]	Control the NVRAM Runtime Variable protection through System Admin Password

Password protection of Runtime Variables [Enabled]

Configuration options: [Disabled] [Enable]

4.5.20 Serial Port Console Redirection

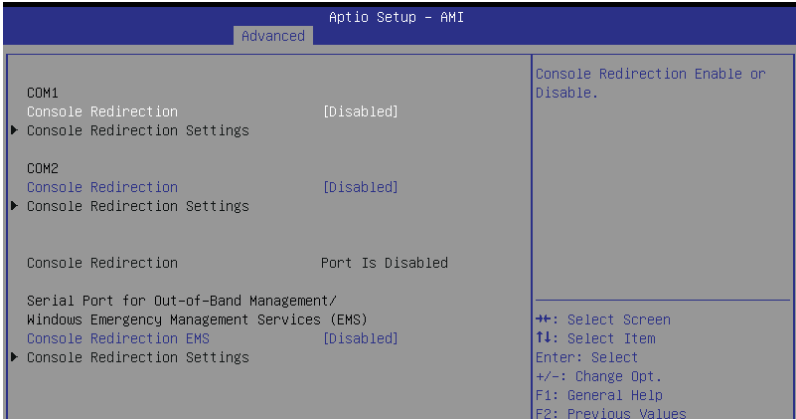

COM1-2

Console Redirection [Disabled]

Allows you to enable or disable the console redirection feature.

Configuration options: [Disabled] [Enabled]



The following items are only available when **Console Redirection** is set to **[Enabled]**.

Console Redirection Settings

These items become configurable only when you enable the **Console Redirection** item. The settings specify how the host computer and the remote computer (which the user is using) will exchange data. Both computers should have the same or compatible settings.

Terminal Type [VT100Plus]

Allows you to set the terminal type.

[VT100] ASCII char set.

[VT100Plus] Extends VT100 to support color, function keys, etc.

[VT-UTF8] Uses UTF8 encoding to map Unicode chars onto 1 or more bytes.

[ANSI] Extended ASCII char set.

Bits per second [115200]

Selects serial port transmission speed. The speed must be matched on the other side. Long or noisy lines may require lower speeds.

Configuration options: [9600] [19200] [38400] [57600] [115200]

Data Bits [8]

Configuration options: [7] [8]

Parity [None]

A parity bit can be sent with the data bits to detect some transmission errors. [Mark] and [Space] parity do not allow for error detection.

[None] None

[Even] parity bit is 0 if the num of 1's in the data bits is even

[Odd] parity bit is 0 if num of 1's in the data bits is odd

[Mark] parity bit is always 1

[Space] parity bit is always 0

Stop Bits [1]

Stop bits indicate the end of a serial data packet. (A start bit indicates the beginning.)

The standard setting is 1 stop bit. Communication with slow devices may require more than 1 stop bit.

Configuration options: [1] [2]

Flow Control [None]

Flow control can prevent data loss from buffer overflow. When sending data, if the receiving buffers are full, a "stop" signal can be sent to stop the data flow. Once the buffers are empty, a "start" signal can be sent to re-start the flow. Hardware flow control uses two wires to send start/stop signals.

Configuration options: [None] [Hardware RTS/CTS]

VT -UTF8 Combo Key Support [Enabled]

This allows you to enable the VT -UTF8 Combination Key Support for ANSI/VT100 terminals.

Configuration options: [Disabled] [Enabled]

Recorder Mode [Disabled]

With this mode enabled only text will be sent. This is to capture Terminal data.

Configuration options: [Disabled] [Enabled]

Resolution 100x31 [Enabled]

This allows you to enable or disable extended terminal resolution.

Configuration options: [Disabled] [Enabled]

Putty Keypad [VT100]

This allows you to select the FunctionKey and Keypad on Putty.

Configuration options: [VT100] [LINUX] [XTERMR6] [SCO] [ESCN] [VT400]

Console Redirection EMS [Disabled]

Allows you to enable or disable the console redirection feature.

Configuration options: [Disabled] [Enabled]



The following items are only available when **Console Redirection EMS** is set to **[Enabled]**.

Console Redirection Settings

Out-of-Band Mgmt Port [COM1]

Microsoft Windows Emergency Management Services (EMS) allow for remote management of a Windows Server OS through a serial port.

Configuration options: [COM1] [COM2 (Disabled)]

Terminal Type [VT-UTF8]

Microsoft Windows Emergency Management Services (EMS) allow for remote management of a Windows Server OS through a serial port.

Configuration options: [VT100] [VT100+] [VT-UTF8] [ANSI]

Bits per second [115200]

Microsoft Windows Emergency Management Services (EMS) allow for remote management of a Windows Server OS through a serial port.

Configuration options: [9600] [19200] [57600] [115200]

Flow Control [None]

Microsoft Windows Emergency Management Services (EMS) allow for remote management of a Windows Server OS through a serial port.

Configuration options: [None] [Hardware RTS/CTS] [Software Xon/Xoff]

4.5.21 Intel TXT Information

Advanced		Aptio Setup - AMI	
Intel TXT Information			
Chipset		Production Fused	
BiosAcm		Production Fused	
Chipset Txt		Supported	
Cpu Txt		Supported	
Error Code		None	
Class Code		None	

4.5.22 Acoustic Management Configuration

Advanced		Aptio Setup - AMI	
Acoustic Management Configuration		Option to Enable or Disable Automatic Acoustic Management	
Acoustic Management Configuration [Disabled]			
▶ SATA Controller 0 - PCI Bus 00 Dev 17 Fun 00			

Acoustic Management Configuration [Disabled]

Configuration options: [Disabled] [Enabled]

SATA Controller 0

Allows you to configure SATA controller settings.

4.5.23 AMI Graphic Output Protocol Policy

Advanced		Aptio Setup - AMI	
ASPEED Graphics PCI Adapter		Output Interface	
ASPEED Graphics Driver			
Output Select [Unknown Device]			

Output Select [Unknown Device]

Configuration options: [Unknown Device]

4.5.24 SIO Common Setting



Lock Legacy Resources [Disabled]

Configuration options: [Disabled] [Enabled]

4.5.25 SIO Configuration

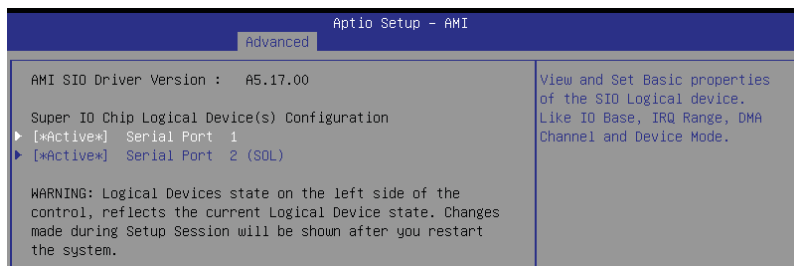

Logical Devices state on the left side of the control, reflects the current Logical Device state. Changes made during Setup Session will be shown after you restart the system.

[*Active*] Serial Port 1 / [*Active*] Serial Port 2 (SOL)

Allows you to view and set basic properties of the SIO Logical device. Like IO Base, IRQ Range, DMA Channel, and Device Mode.

Use This Device [Enabled]

Allows you to enable or disable this Logical Device.

Configuration options: [Disabled] [Enabled]



The following items are only available when **Use This Device** is set to **[Enabled]**.

Possible [Use Automatic Settings]

Configuration options: [Use Automatic Settings] [IO=3F8h; IRQ=4; DMA;]
[IO=3F8h; IRQ=3, 4, 5, 7, 9, 10, 11, 12; DMA;] [IO=2F8h; IRQ=3, 4, 5, 7, 9,
10, 11, 12; DMA;] [IO=3E8h; IRQ=3, 4, 5, 7, 9, 10, 11, 12; DMA;] [IO=2E8h;
IRQ=3, 4, 5, 7, 9, 10, 11, 12; DMA;]

4.5.26 PCI Subsystem Settings

Aptio Setup - AMI		
Advanced		
PCI Bus Driver Version	A5.01.30	Value to be programmed into PCI Latency Timer Register.
PCI Devices Common Settings:		
PCI Latency Timer	[32 PCI Bus Clocks]	
PCI-X Latency Timer	[64 PCI Bus Clocks]	
VGA Palette Snoop	[Disabled]	
PERR# Generation	[Disabled]	
SERR# Generation	[Disabled]	
Re-Size BAR Support	[Disabled]	
SR-IOV Support	[Disabled]	
BME DMA Mitigation	[Disabled]	
▶ PCI Express Settings		
▶ PCI Express GEN 2 Settings		
		↔: Select Screen
		↑↓: Select Item

PCI Latency Timer [32 PCI Bus Clocks]

Configuration options: [32 PCI Bus Clocks] [64 PCI Bus Clocks] [96 PCI Bus Clocks] [128 PCI Bus Clocks] [160 PCI Bus Clocks] [192 PCI Bus Clocks] [224 PCI Bus Clocks] [248 PCI Bus Clocks]

PCI-X Latency Timer [64 PCI Bus Clocks]

Configuration options: [32 PCI Bus Clocks] [64 PCI Bus Clocks] [96 PCI Bus Clocks] [128 PCI Bus Clocks] [160 PCI Bus Clocks] [192 PCI Bus Clocks] [224 PCI Bus Clocks] [248 PCI Bus Clocks]

VGA Palette Snoop [Disabled]

Configuration options: [Disabled] [Enabled]

PERR# Generation [Disabled]

Configuration options: [Disabled] [Enabled]

SERR# Generation [Disabled]

Configuration options: [Disabled] [Enabled]

Re-Size BAR Support [Disabled]

Configuration options: [Disabled] [Auto]

SR-IOV Support [Disabled]

Configuration options: [Disabled] [Enabled]

BME DMA Mitigation [Disabled]

Configuration options: [Disabled] [Enabled]

PCI Express Settings

Allows you to configure PCI Express options.

PCI Express GEN 2 Settings

Allows you to configure PCI Express Gen 2 options.

4.5.27 USB Configuration

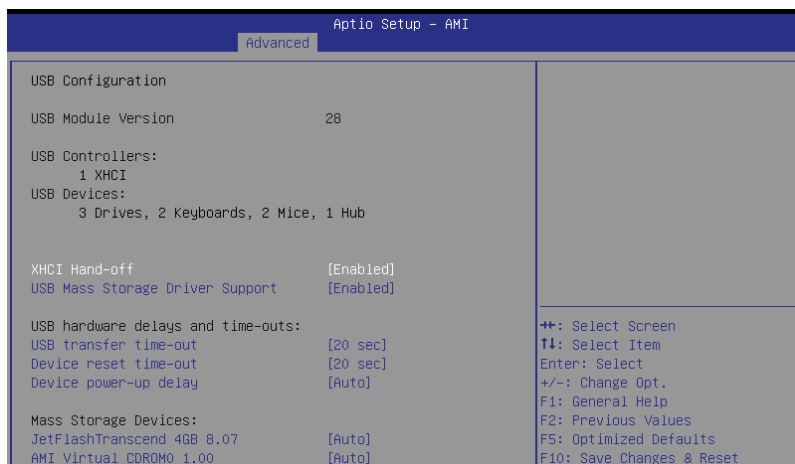

XHCI Hand-off [Enabled]

Allows you to enable or disable workaround for OSes without XHCI hand-off support. The XHCI ownership change should be claimed by XHCI driver.

Configuration options: [Disabled] [Enabled]

USB Mass Storage Driver Support [Enabled]

Allows you to enable or disable USB Mass Storage driver support.

Configuration options: [Disabled] [Enabled]

USB hardware delays and time-outs

USB transfer time-out [20 sec]

Allows you to set the time-out value for Control, Bulk, and Interrupt transfers.

Configuration options: [1 sec] [5 sec] [10 sec] [20 sec]

Device reset time-out [20 sec]

Allows you to set the device reset time-out value.

Configuration options: [10 sec] [20 sec] [30 sec] [40 sec]

Device power-up delay [Auto]

Allows you to set the maximum time the device takes before the device reports itself to the host controller properly. **[Auto]** uses default value; for a Root port it is 100 ms, for a Hub port the delay is taken from Hub descriptor.

Configuration options: [Auto] [Manual]



The following item appears only when **Device power-up delay** is set to **[Manual]**.

Device power-up delay in seconds [5]

Allows you to set the device power-up delay in seconds. Use the <+> or <-> to adjust the value. The values range from 1 to 40.

Mass Storage Devices

Allows you to select the mass storage device emulation type for devices connected.

Configuration options: [Auto] [Floppy] [Forced FDD] [Hard Disk] [CD-ROM]

4.5.28 Network Stack Configuration

Advanced		
Aptio Setup - AMI		
Network Stack	[Enabled]	Enable/Disable UEFI Network Stack
IPv4 PXE Support	[Enabled]	
IPv4 HTTP Support	[Disabled]	
IPv6 PXE Support	[Disabled]	
IPv6 HTTP Support	[Disabled]	
PXE boot wait time	0	
Media detect count	1	

Network Stack [Enabled]

Allows you to enable or disable UEFI Network Stack.

Configuration options: [Disabled] [Enabled]



The following items appear only when **Network Stack** is set to **[Enabled]**.

IPv4 PXE Support [Enabled]

Enables or disables the IPv4 PXE Boot Support. If disabled, IPv4 PXE boot option will not be created.

Configuration options: [Disabled] [Enabled]

IPv4 HTTP Support [Disabled]

Enables or disables the IPv4 HTTP Boot Support. If disabled, IPv4 PXE boot option will not be created.

Configuration options: [Disabled] [Enabled]

IPv6 PXE Support [Disabled]

Enables or disables the IPv6 PXE Boot Support. If disabled, IPv6 PXE boot option will not be created.

Configuration options: [Disabled] [Enabled]

IPv6 HTTP Support [Disabled]

Enables or disables the IPv6 HTTP Boot Support. If disabled, IPv6 PXE boot option will not be created.

Configuration options: [Disabled] [Enabled]

PXE boot wait time [0]

Set the wait time to press ESC key to abort the PXE boot. Use the <+> or <-> to adjust the value. The values range from 0 to 5.

Media detect count [1]

Set the number of times presence of media will be checked. Use the <+> or <-> to adjust the value. The values range from 1 to 50.

4.5.29 NVMe Configuration

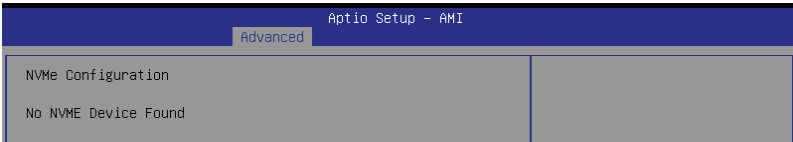

4.5.30 APM Configuration

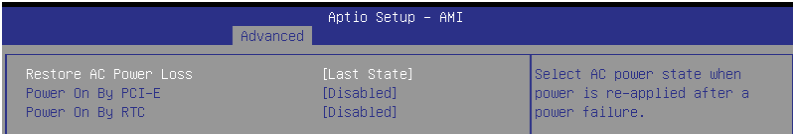

Restore AC Power Loss [Last State]

When set to **[Power Off]**, the system goes into off state after an AC power loss. When set to **[Power On]**, the system will reboot after an AC power loss. When set to **[Last State]**, the system goes into either off or on state, whatever the system state was before the AC power loss.

Configuration options: [Power Off] [Power On] [Last State]

Power On By PCI-E/PCI [Disabled]

[Disabled] Disables the PCI/PCIe devices to generate a wake event.

[Enabled] Enables the PCI/PCIe devices to generate a wake event.

Power On By RTC [Disabled]

[Disabled] Disables RTC to generate a wake event.

[Enabled] When set to [Enabled], the items **RTC Alarm Date (Days)** and **Hour/Minute/Second** will become user-configurable with set values.

4.5.31 Third-party UEFI driver configurations

Additional configuration options for third-party UEFI drivers installed to the system will appear in the section marked in red in the screenshot below.

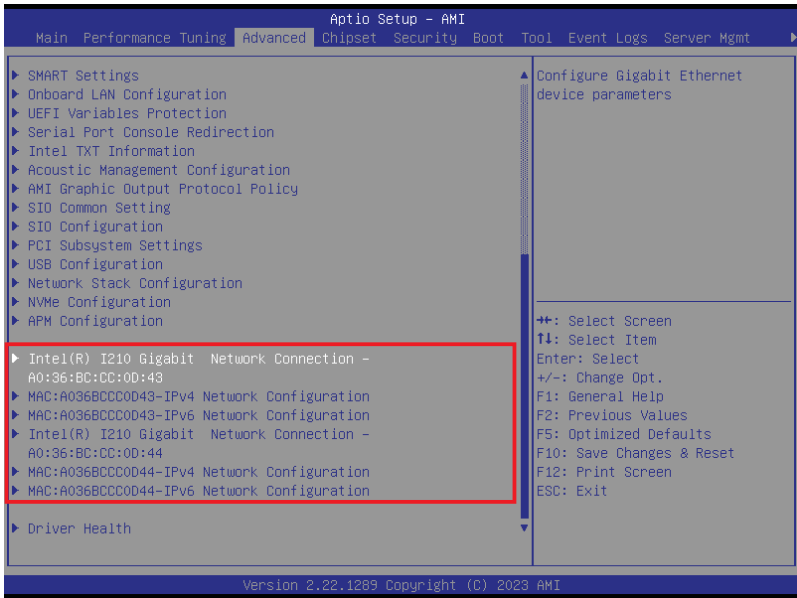

4.5.32 Driver Health

This page will display the driver and controller health status.

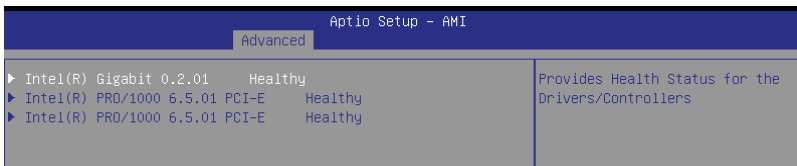

4.6 Security menu

This menu allows a new password to be created or a current password to be changed. The menu also enables or disables the Secure Boot state and lets the user configure the System Mode state.

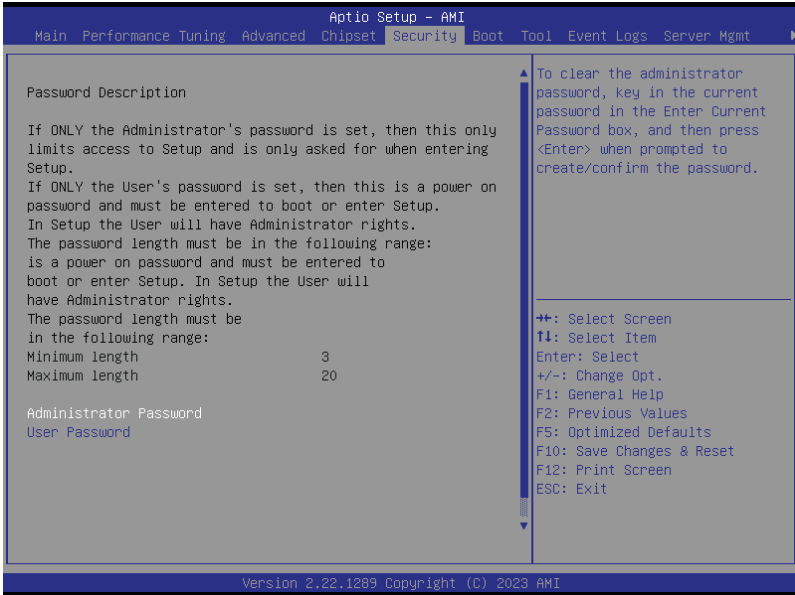

Administrator Password

To set an administrator password:

1. Select the Administrator Password item and press <Enter>.
2. From the Create New Password box, key in a password, then press <Enter>.
3. Confirm the password when prompted.

To change an administrator password:

1. Select the Administrator Password item and press <Enter>.
2. From the Enter Current Password box, key in the current password, then press <Enter>.
3. From the Create New Password box, key in a new password, then press <Enter>.
4. Confirm the password when prompted.



To clear the administrator password, follow the same steps as in changing an administrator password, but press <Enter> when prompted to create/confirm the password.

User Password

To set a user password:

1. Select the User Password item and press <Enter>.
2. From the Create New Password box, key in a password, then press <Enter>.
3. Confirm the password when prompted.

To change a user password:

1. Select the User Password item and press <Enter>.
2. From the Enter Current Password box, key in the current password, then press <Enter>.
3. From the Create New Password box, key in a new password, then press <Enter>.
4. Confirm the password when prompted.

To clear a user password:

1. Select the Clear User Password item and press <Enter>.
2. Select Yes from the Warning message window then press <Enter>.

Secure Boot [Disabled]

Secure Boot feature is Active if Secure Boot is set to **[Enabled]**, Platform Key (PK) is enrolled and the System is in User mode. Mode change requires a platform reset.
Configuration options: [Disabled] [Enabled]

Secure Boot Mode [Custom]

Allows you to set the Secure Boot selector.
Configuration options: [Custom] [Standard]



The following items are available only when **Secure Boot Mode** is set to **[Custom]**.

Install Default Secure Boot Keys

This option will load the default secure boot keys, including the PK (Platform key), KEK (key-exchange key), db (signature database), and dbx (revoked signature database). All the secure boot keys states will change from unloaded to loaded. Save changes and reset the system for the changes to take effect.

Clear Secure Boot Keys

This option will delete all previously applied secure boot keys, including the PK (Platform key), KEK (key-exchange key), db (signature database), and dbx (revoked signature database). All the secure boot keys states will change from unloaded to loaded. Save changes and reset the system for the changes to take effect.

Key Management

This item only appears when the item **Secure Boot Mode** is set to **[Custom]**. The Key Management item allows you to modify Secure Boot variables and set Key Management page.

Factory Key Provision [Enabled]

Allows you to provision factory default Secure Boot keys when the system is in Setup Mode.

Configuration options: [Disabled] [Enabled]

Install Default Secure Boot Keys

This option will load the default secure boot keys, including the PK (Platform key), KEK (key-exchange key), db (signature database), and dbx (revoked signature database). All the secure boot keys states will change from unloaded to loaded. Save changes and reset the system for the changes to take effect.

Clear Secure Boot Keys

This option will delete all previously applied secure boot keys, including the PK (Platform key), KEK (key-exchange key), db (signature database), and dbx (revoked signature database). All the secure boot keys states will change from unloaded to loaded. Save changes and reset the system for the changes to take effect.

Save all Secure Boot Variables

This option will save NVRAM content of Secure Boot policy variables to the file (EFI_SIGNATURE_LIST data format) in root folder on a target file system device.

Enroll Efi Image

This item will allow the image to run in Secure Boot mode. Enroll SHA256 Hash certificate of a PE image into Authorized Signature Database (db).

Device Guard Ready

Remove 'UEFI CA' from DB

Remove Microsoft UEFI CA from Secure Boot DB.

Restore DB defaults

Restore DB variable to factory defaults.

PK Management

Configuration options: [Details] [Save To File] [Set New Key] [Delete key]

KEK Management / DB Management / DBX Management

Configuration options: [Details] [Save To File] [Set New Key] [Append Key] [Delete key]

Authorized TimeStamps / OsRecovery Signatures

Configuration options: [Set New Key] [Append Key]

4.7 Boot menu

The Boot menu items allow you to change the system boot options.

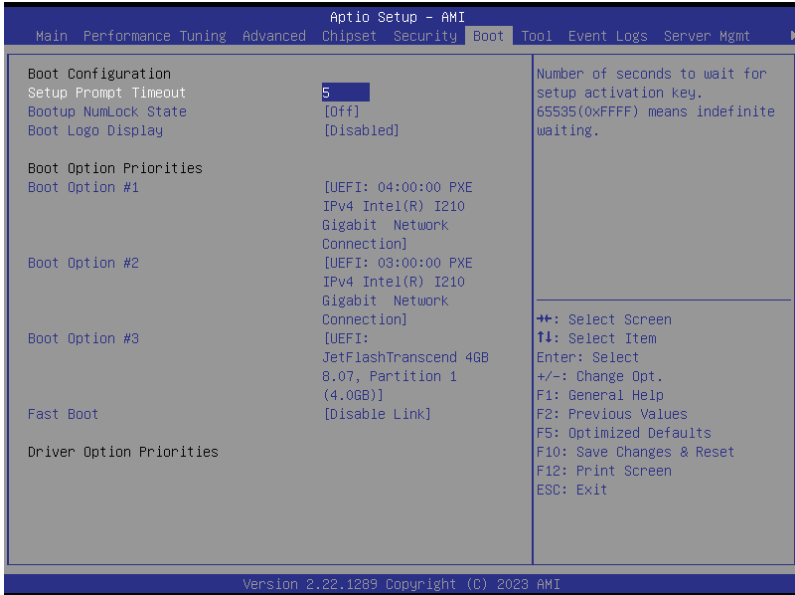

Setup Prompt Timeout [5]

Allows you to set the number of seconds that the firmware waits before initiating the original default boot selection. 65535(0xFFFF) means indefinite waiting. Use the <+> or <-> to adjust the value.

Bootup NumLock State [Off]

Allows you to select the power-on state for the NumLock.
Configuration options: [Off] [On]

Boot Logo Display [Disabled]

[Disabled] Hide the logo during POST.
[Enabled] Display the logo during POST.

Boot Option Priorities

These items specify the boot device priority sequence from the available devices. The number of device items that appears on the screen depends on the number of devices installed in the system.



To select the boot device during system startup, press <F8> when ASUS Logo appears.

Fast Boot [Disable Link]

Allows you to enable or disable boot with initialization of a minimal set of devices required to launch active boot option. This has no effect for BBS boot options.

Configuration options: [Disable Link] [Enabled]



The following items appear only when **Fast Boot** is set to **[Enabled]**.

SATA Support [Last Boot SATA Devices Only]

Configuration options: [Last Boot SATA Devices Only] [All SATA Devices]

NVMe Support [Enabled]

Configuration options: [Disable Link] [Enabled]

USB Support [Full Initial]

Configuration options: [Disable Link] [Full Initial] [Partial Initial]

PS2 Devices Support [Enabled]

Configuration options: [Disable Link] [Enabled]

Network Stack Driver Support [Disable Link]

Configuration options: [Disable Link] [Enabled]

Redirection Support [Disable Link]

Configuration options: [Disable Link] [Enabled]

4.8 Tool menu

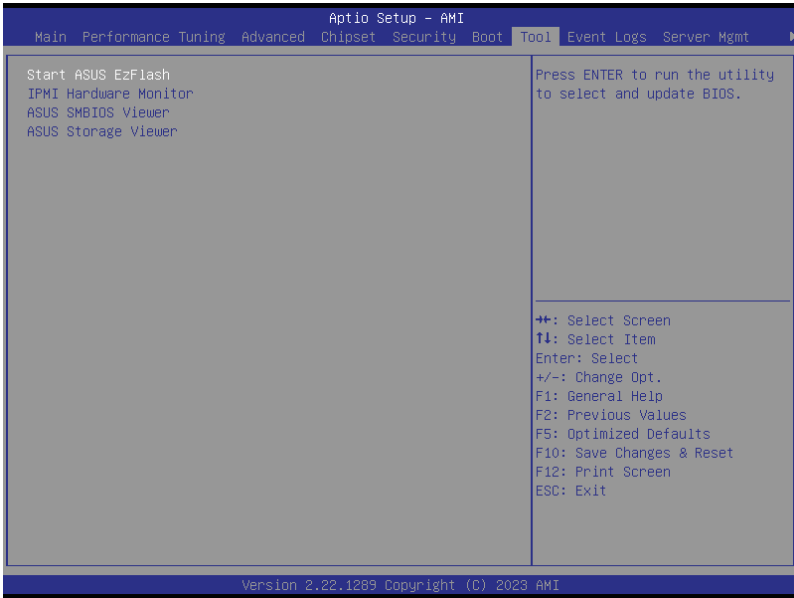

Start ASUS EzFlash

Allows you to start the ASUS EzFlash BIOS ROM Utility. Refer to the **ASUS EzFlash Utility** section for details.

IPMI Hardware Monitor

Allows you to start the IPMI hardware monitor.

ASUS SMBIOS Viewer

Allows you to start the ASUS SMBIOS Viewer.

ASUS Storage Viewer

Allows you to start the ASUS Storage Viewer.

4.9 Event Logs menu

The Event Logs menu items allow you to change the event log settings and view the system event logs.

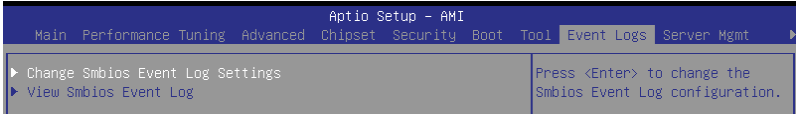

4.9.1 Change Smbios Event Log Settings

Press <Enter> to change the Smbios Event Log configuration.



All values changed here do not take effect until computer is restarted.

Smbios Event Log [Enabled]

Change this to enable or disable all features of Smbios Event Logging during boot.
Configuration options: [Disabled] [Enabled]



The following item appears only when **Smbios Event Log** is set to **[Enabled]**.

Erase Event Log [No]

Choose options for erasing Smbios Event Log. Erasing is done prior to any logging activation during reset.

Configuration options: [No] [Yes, Next reset] [Yes, Every reset]

When Log is Full [Do Nothing]

Choose options for reactions to a full Smbios Event Log.
Configuration options: [Do Nothing] [Erase Immediately]

Log System Boot Event [Enabled]

Configuration options: [Disabled] [Enabled]

MECI [1]

Allows you to set the Multiple Event Count Increment.

MECI [60]

Allows you to set the Multiple Event Time Window.

Log EFI Status Code [Enabled]

Configuration options: [Disabled] [Enabled]

Convert EFI Status Codes to Standard Smbios Type [Disabled]

Configuration options: [Disabled] [Enabled]

4.9.2 View Smbios Event Log

Press <Enter> to view all Smbios event logs.

4.10 Server Mgmt menu

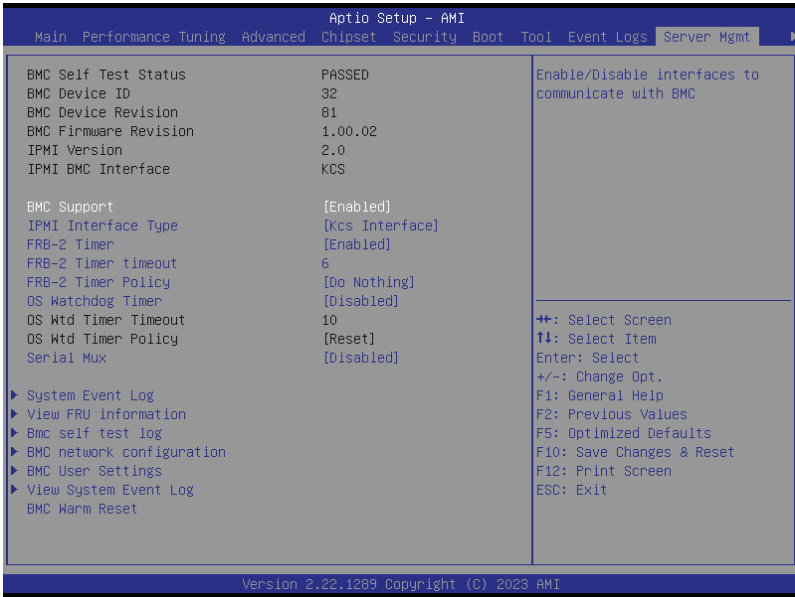

BMC Support [Enabled]

Configuration options: [Disabled] [Enabled]



The following items appear only when **BMC Support** is set to **[Enabled]**.

IPMI Interface Type [KCS Interface]

Configuration options: [KCS Interface]

FRB-2 Timer [Enabled]

Configuration options: [Disabled] [Enabled]



The following items appear only when **FRB-2 Timer** is set to **[Enabled]**.

FRB-2 Timer Timeout [6]

Allows you to set the FRB-2 timer timeout in minutes.

FRB-2 Timer Policy [Do Nothing]

Configuration options: [Do Nothing] [Reset] [Power Down] [Power Cycle]

OS Watchdog Timer [Disabled]

Configuration options: [Disabled] [Enabled]



The following items are configurable only when **OS Watchdog Timer** is set to **[Enabled]**.

OS Wtd Timer Timeout [10]

Allows you to set the OS watchdog timer timeout in minutes.

OS Wtd Timer Policy [Reset]

Configuration options: [Do Nothing] [Reset] [Power Down] [Power Cycle]

Serial Mux [Disabled]

Configuration options: [Disabled] [Enabled]

System Event Log

Allows you to configure System Event Log options.

View FRU Information

Allows you to view the FRU information.

BMC Self Test Log

Allows you to view the BMC Self Test log.

BMC Network Configuration

Allows you to configure BMC network options.

BMC User Settings

Allows you to configure BMC user options.

View System Event Log

Allows you to view the System Event log.

BMC Warm Reset

Allows you to initiate a warm reset of the BMC.

4.11 Exit menu

The Exit menu items allow you to save or discard your changes to the BIOS items.

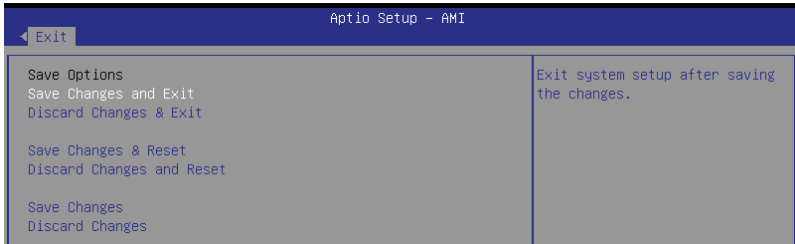

Save Changes and Exit

Exit system setup after saving any changes.

Discard Changes and Exit

Exit system setup without saving any changes.

Save Changes and Reset

Reset the system after saving the changes.

Discard Changes and Reset

Reset system setup without saving any changes.

Save Changes

Save changes done so far to any of the setup options.

Discard Changes

Discard changes done so far to any of the setup options.

Load Optimized Defaults

Restore/load default values for all the setup options.

Save as User Defaults

Save current changes as user default values for all the setup options.

Restore User Defaults

Restore/load saved user default values for all the setup options.

Boot Override

These items displays the available devices. The device items that appears on the screen depends on the number of devices installed in the system. Click an item to start booting from the selected device.

Launch EFI Shell from filesystem device

This item allows you to attempt to launch the EFI Shell application (shellx64.efi) from one of the available filesystem devices.

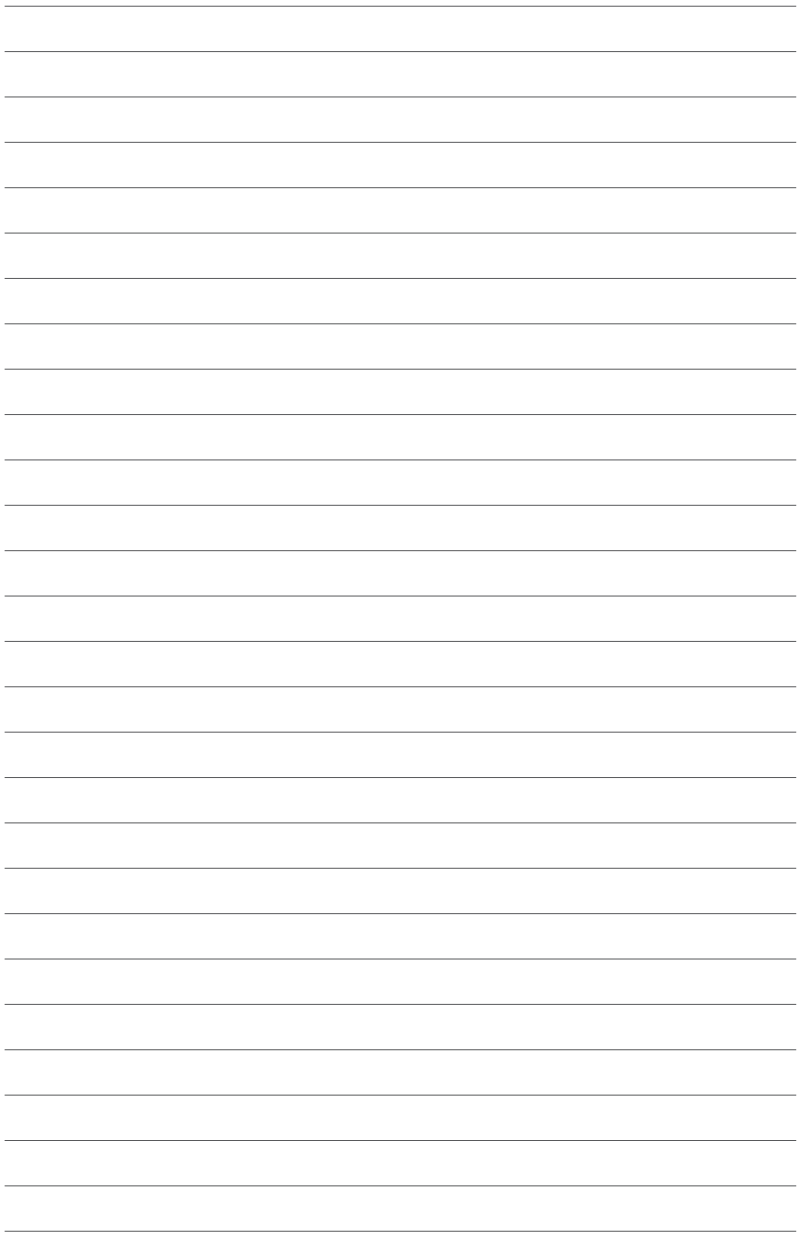

RAID Configuration

5

This chapter provides instructions for setting up, creating, and configuring RAID sets using the available utilities.

5.1 Setting up RAID

The motherboard supports the Intel® Rapid Storage Technology enterprise Option ROM Utility with RAID 0, RAID 1, RAID 10, and RAID 5 support (for Windows OS and Linux).

5.1.1 RAID definitions

RAID 0 (Data striping) optimizes two identical hard disk drives to read and write data in parallel, interleaved stacks. Two hard disks perform the same work as a single drive but at a sustained data transfer rate, double that of a single disk alone, thus improving data access and storage. Use of two new identical hard disk drives is required for this setup.

RAID 1 (Data mirroring) copies and maintains an identical image of data from one drive to a second drive. If one drive fails, the disk array management software directs all applications to the surviving drive as it contains a complete copy of the data in the other drive. This RAID configuration provides data protection and increases fault tolerance to the entire system. Use two new drives or use an existing drive and a new drive for this setup. The new drive must be of the same size or larger than the existing drive.

RAID 10 is data striping and data mirroring combined without parity (redundancy data) having to be calculated and written. With the RAID 10 configuration you get all the benefits of both RAID 0 and RAID 1 configurations. Use four new hard disk drives or use an existing drive and three new drives for this setup.

RAID 5 stripes both data and parity information across three or more hard disk drives. Among the advantages of RAID 5 configuration include better HDD performance, fault tolerance, and higher storage capacity. The RAID 5 configuration is best suited for transaction processing, relational database applications, enterprise resource planning, and other business systems. Use a minimum of three identical hard disk drives for this setup.



If you want to boot the system from a hard disk drive included in a created RAID set, copy first the RAID driver from the support DVD to a floppy disk before you install an operating system to the selected hard disk drive.

5.1.2 Installing hard disk drives

The motherboard supports Serial ATA for RAID set configuration. For optimal performance, install identical drives of the same model and capacity when creating a disk array.

To install the SATA hard disks for RAID configuration:

1. Install the SATA hard disks into the drive bays following the instructions in the system user guide.
2. Connect a SATA signal cable to the signal connector at the back of each drive and to the SATA connector on the motherboard.
3. Connect a SATA power cable to the power connector on each drive.

5.1.3 Setting the RAID item in BIOS

You must set the RAID item in the BIOS Setup before you can create a RAID set from SATA hard disk drives attached to the SATA connectors supported by the chipset.

To do this:

1. Enter the BIOS Setup during POST.
2. Go to the **Advanced** menu > **PCH Configuration** > **PCH Storage Configuration**, then press <Enter>.
3. Set **SATA Mode Selection** to **[Intel RSTe Premium With Intel Optane System Acceleration]**.
4. Press <F10> to save your changes and exit the BIOS Setup.



Refer to Chapter 4 for details on entering and navigating through the BIOS Setup.

5.2 Intel® Virtual Raid on CPU in BIOS

This feature allows you to do CPU RAID functions with Intel® CPU RSTe.

1. Enter the BIOS Setup during POST.
2. Go to the **Advanced** menu > **Intel(R) VROC SATA Controller** then press <Enter> to display the Intel® Virtual Raid on CPU menu.



Refer to the **BIOS Setup** chapter for details on entering and navigating through the BIOS Setup.

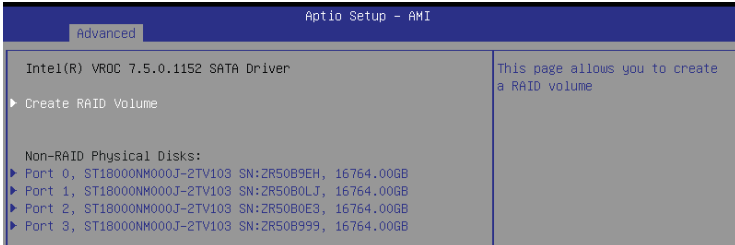

5.2.1 Creating a RAID set

To create a RAID set:

1. From the Intel® Virtual Raid on CPU menu, select **Create RAID Volume** and press <Enter>. The following screen appears:

The screenshot shows the 'Advanced' menu in 'Aptio Setup - AMI'. The 'Create RAID Volume' screen is active. It displays the following configuration: Name: Volume1, RAID Level: [RAID0(Stripe)]. Under 'Select Disks', four ports are listed, each with a checked box: Port 0, ST18000NH000J-2TV103, SN:ZR50B0LJ, 16764.00GB; Port 1, ST18000NH000J-2TV103, SN:ZR50B9EH, 16764.00GB; Port 2, ST18000NH000J-2TV103, SN:ZR50B0E3, 16764.00GB; Port 3, ST18000NH000J-2TV103, SN:ZR50B999, 16764.00GB. The 'Strip Size' is set to [128KB] and 'Capacity (GB)' is 3185.15. A blue arrow points to the 'Create Volume' option at the bottom left. On the right side, there is a legend: 'X - to Select Disk', '++: Select Screen', 'F4: Select Item', 'Enter: Select', '+/-: Change Opt.', 'F1: General Help', 'F2: Previous Values', 'F5: Optimized Defaults', and 'F10: Save Changes & Reset'.

2. When the **Name** item is selected, enter a name for the RAID set and press <Enter>.
3. When the **RAID Level** item is selected, press <Enter> to select the RAID level to create, and then press <Enter>.
4. Under **Select Disks**, press <Enter> and select **X** for the disks you want to include in the RAID set.
5. When the **Strip Size** item is selected, press <Enter> to select strip size for the RAID array (for RAID 0, 10 and 5 only), and then press <Enter>. The available strip size values range from 4 KB to 128 KB. The following are typical values:
 - RAID 0: 128 KB
 - RAID 10: 64 KB
 - RAID 5: 64 KB



We recommend a lower strip size for server systems, and a higher strip size for multimedia computer systems used mainly for audio and video editing.

6. When the **Capacity (GB)** item is selected, enter the RAID volume capacity that you want and press <Enter>. The default value indicates the maximum allowed capacity.
7. When the **Create Volume** item is selected, press <Enter> to create the RAID volume and return to the Intel® Rapid Storage Technology menu.

5.2.2 Deleting a RAID set



Be cautious when deleting a RAID set. You will lose all data on the hard disk drives when you delete a RAID set.

To delete a RAID set:

1. From the Intel® Virtual Raid on CPU menu, select the RAID volume you want to delete and press <Enter>. The following screen appears:

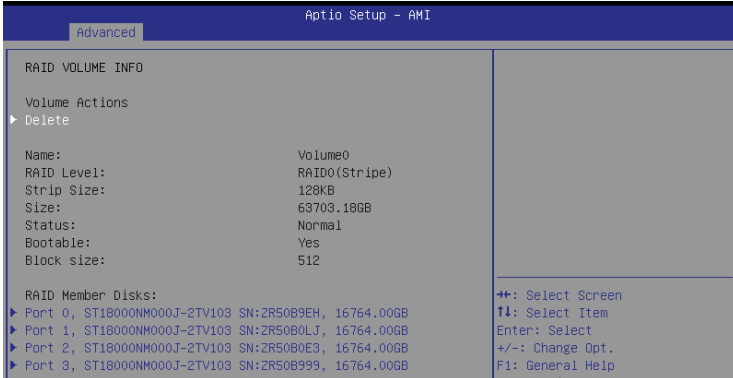

2. When the **Delete** item is selected, press <Enter>, then select **Yes** to delete the RAID volume and return to the Intel® Virtual Raid on CPU menu, or select **No** to cancel.



5.3 Intel® Rapid Storage Technology enterprise (Windows)

The Intel® Rapid Storage Technology enterprise allows you to create RAID 0, RAID 1, RAID 10 (RAID 1+0), and RAID 5 set(s) from Serial ATA hard disk drives that are connected to the Serial ATA connectors supported by the Southbridge.



You need to manually install the Intel® Rapid Storage Technology enterprise utility on a Windows® operating system. Please refer to the installation instructions in Chapter 6.

To enter the Intel® Rapid Storage Technology enterprise utility under Windows operating system:

1. Turn on the system and go to the windows desktop.
2. Click the **Intel(R) Virtual RAID on CPU** icon to display the main menu.

Your storage system is configured for data protection, increased performance and optimal data storage capacity. You can create additional volumes to further optimize your storage system.

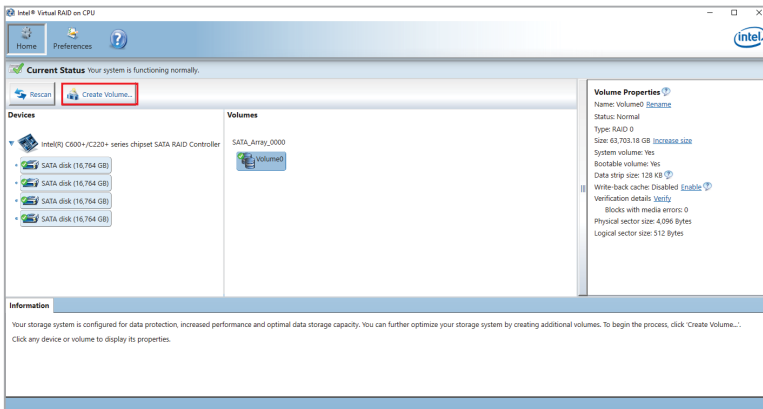

You can click **Rescan** to re-scan any attached hard disks.

5.3.1 Creating a RAID set

To create a RAID set:

1. From the utility main menu, select **Create Volume** and select volume type.
2. Click **Next**.

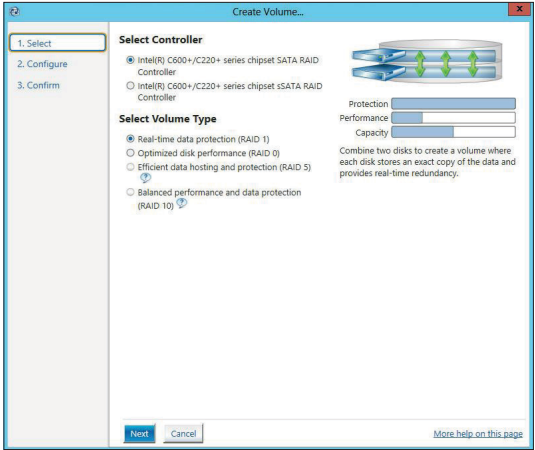

3. Enter a name for the RAID set, then select the array disks.
4. Select **Volume Size** tab, you can drag the bar to decide the volume size.
5. Click **Next**.

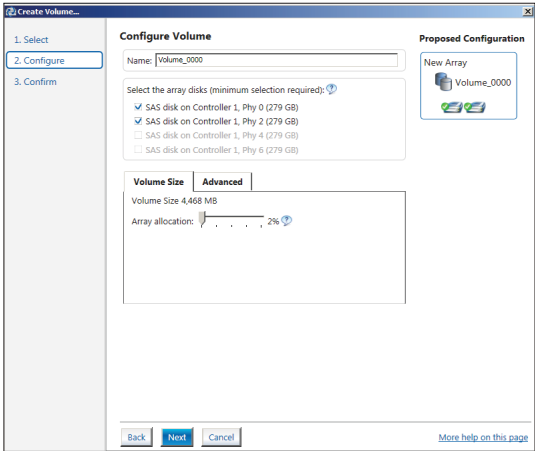

- If you do not want to keep the data on one of the selected disks, select **NO** when prompted.
- If you want to **Enable volume write-back cache** or **Initialize volume**, click **Advanced**.

6. Confirm the volume creation, then click **Create Volume** to continue.



This process could take a while depending on the number and size of the disks. You can continue using other applications during this time.

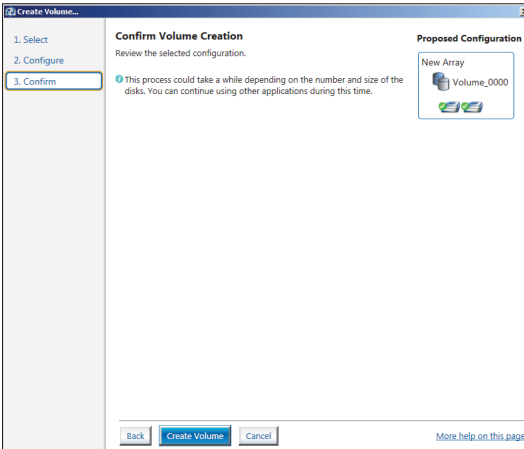

7. Wait until the process is completed, then click **OK** when prompted.

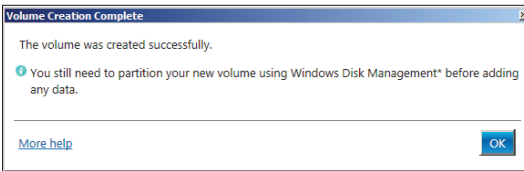

You still need to partition your new volume using Windows Disk Management before adding any data.

The RAID set is displayed in the **Volumes** list and you can change the settings in **Volume Properties**.

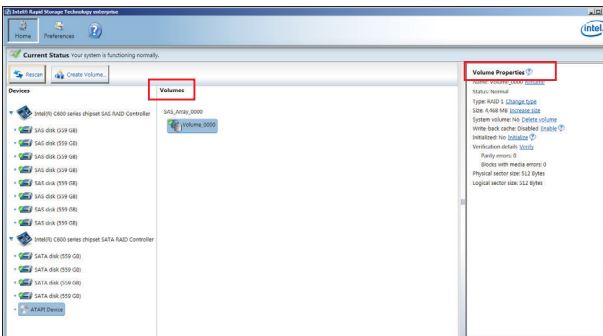

5.3.2 Changing a Volume Type

To change the volume type in **Volume Properties**:

1. Click the SATA array items you want to change in **Volumes** field.
2. From the **Volume Properties** field, select **Type:RAID 1 Change type**.

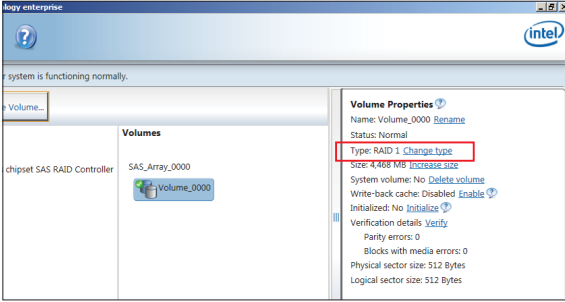

3. You can change the **Name**, **Select the new volume type**, and **Select additional disks to include in the new volume** if needed.
4. Select the **Data stripe size** for the RAID array (for RAID 0, 10 and 5 only), and click **OK**. The available stripe size values range from 4 KB to 128 KB. The following are typical values:
RAID 0: 128KB
RAID 10: 64KB
RAID 5: 64KB

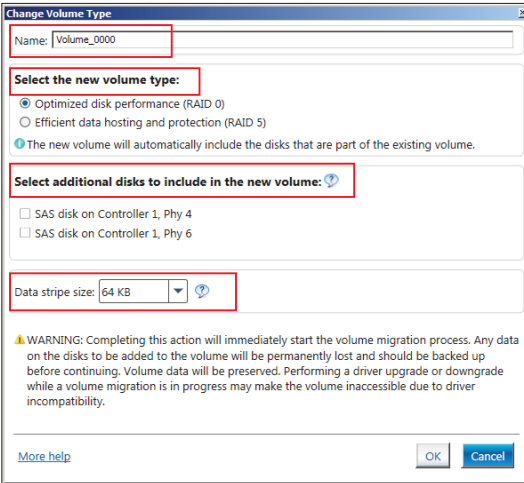

We recommend a lower stripe size for server systems, and a higher stripe size for multimedia computer systems used mainly for audio and video editing.

5.3.3 Deleting a volume



Be cautious when deleting a volume. You will lose all data on the hard disk drives. Before you proceed, ensure that you back up all your important data from your hard drives.

To delete a volume:

1. From the utility main menu, select the volume (exp. Volume_0000) in **Volumes** field you want to delete.

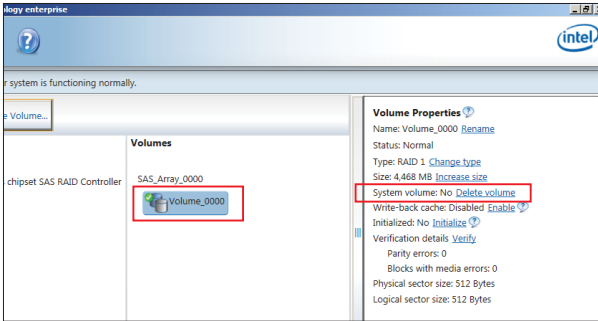

2. Select **Delete volume** in **Volume Properties** field. The following screen appears.

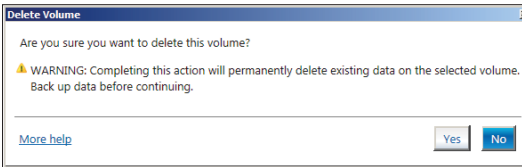

3. Click **Yes** to delete the volume and return to the utility main menu, or click **No** to return to the main menu.

5.3.4 Preferences

System Preferences

Allow you to set to show the notification area icon and show system information, warning, or errors here.

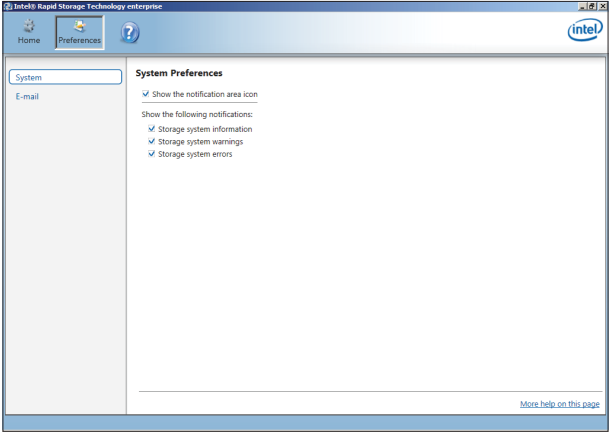

E-Mail Preferences

Allow you to set to sent e-mail of the following events:

- Storage system information
- Storage system warnings
- Storage system errors

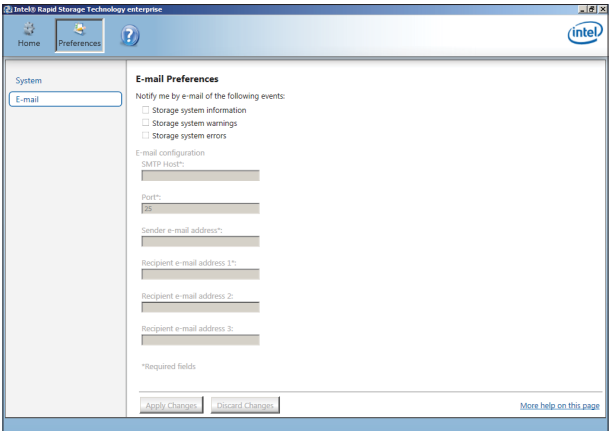

Driver Installation

6

This chapter provides instructions for installing the necessary drivers for different system components.

6.1 RAID driver installation

After creating the RAID sets for your server system, you are now ready to install an operating system to the independent hard disk drive or bootable array. This part provides the instructions on how to install the RAID controller drivers during OS installation.

6.1.1 Creating a USB flash drive with RAID drive

When installing Windows® Server OS, you can load the RAID driver from a USB flash drive. You can create a USB flash drive with RAID driver in Windows by copying the files from the support DVD to the USB flash drive.

To copy the RAID driver to a USB flash drive in Windows environment:

1. Place the motherboard support DVD in the optical drive.
2. Connect a USB flash drive to your system.
3. Click on the optical drive to browse the contents of the support DVD.
4. Click **Drivers > C25x INTEL RAID > Windows> Driver** and then copy the RAID driver folder to the USB flash drive.

6.1.2 Installing the RAID controller driver

During Windows® Server 2012 R2, 2016, or 2019 OS installation

To install the RAID controller driver when installing Windows® Server OS:

1. Boot the computer using the Windows® Server installation disc. Follow the onscreen instructions to start installing Windows® Server.
2. When prompted to choose a type of installation, click **Custom: Install Windows only (advanced)**.

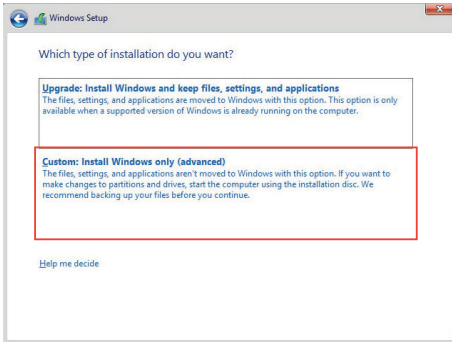

3. Click **Load Driver**.

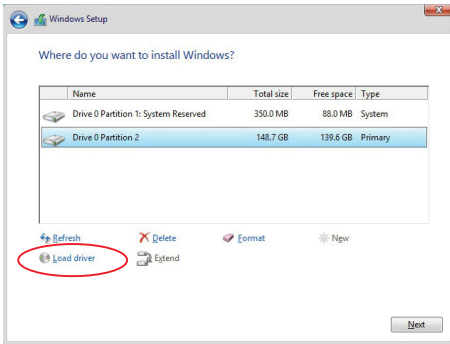

4. A message appears reminding you to insert the installation media containing the driver of the RAID controller driver (the installation media can be a CD, DVD, or USB flash drive).
- If you have only one optical drive installed in your system, eject the Windows OS installation disc and replace with the motherboard Support DVD into the optical drive.
 - Or you may connect a USB flash drive containing the RAID controller driver.

Click **Browse** to continue.



5. Locate the driver in the corresponding folder of the Support DVD or USB flash drive and then click **OK** to continue.
6. Select the RAID controller driver you need from the list and click **Next**.

7. When the system finishes loading the RAID driver,
 - Replace the motherboard Support DVD with the Windows Server installation disc.
 - Remove the USB flash drive.

Select the drive to install Windows and click **Next**.

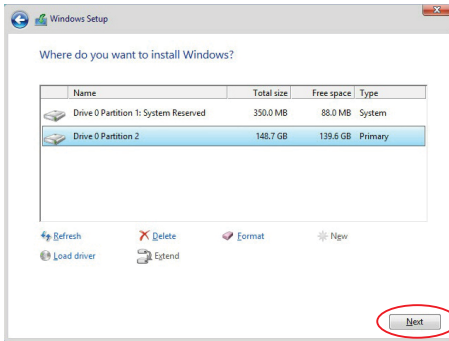

8. Setup then proceeds with the OS installation. Follow the onscreen instructions to continue.

6.2 Running the Support DVD

The support DVD that is bundled with your motherboard contains drivers, management applications, and utilities that you can install to maximize the features of your motherboard.



The contents of the support DVD are subject to change at any time without notice. Visit the ASUS website (www.asus.com) for the latest updates on software and utilities.

The main screen of the Support DVD contains the following tabs:

1. Drivers - Shows the available device drivers that the system detects.
2. Utilities - Displays the software applications and utilities that the motherboard supports.
3. Manual - Provides the link to the user guide(s).



You need an internet browser installed in your OS to view the User Guide.

4. Contact - Displays the ASUS contact information, e-mail addresses, and useful links if you need more information or technical support for your motherboard.

Appendix

This appendix includes additional information that you may refer to when configuring the motherboard.

Block diagram

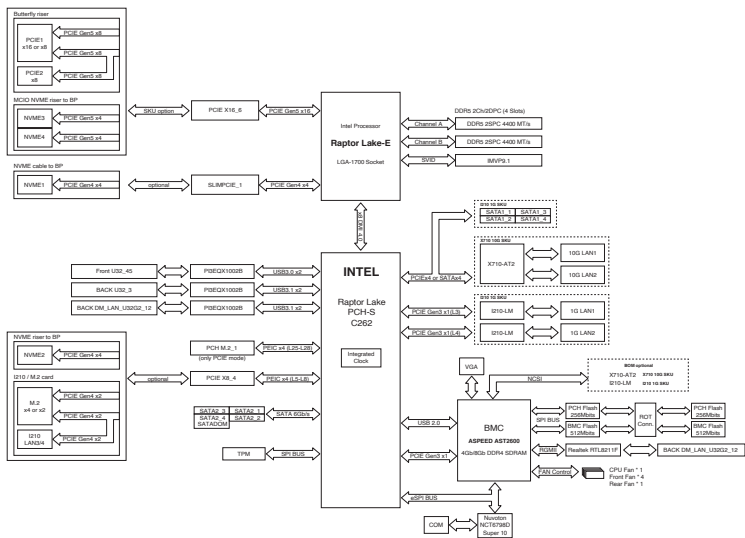

Q-Code table

POST CODE	DESCRIPTION
0x10	PEI, core start
0x11	PEI, Pre-CPU initial
0x15	PEI, Pre-North bridge initial
0x19	PEI, Pre-South bridge initial
0x2B	PEI, Read memory SPD
0x2C	PEI, Detect memory
0x2D	PEI, Check memory timing
0x2E	PEI, Check memory configuration
0x2F	PEI, Memory initial
0x31	PEI, Memory installed
0x32	PEI, CPU initial
0x33	PEI, CPU cache initial
0x34	PEI, CPU AP initial
0x35	PEI, Check CPU BAP
0x36	PEI, CPU SMM initial
0x37	PEI, North bridge initial
0x3B	PEI, South bridge initial
0x4F	PEI, Prepare for DXE
0x60	DXE, core start
0x61	DXE, NVRAM initial
0x62	DXE, South bridge initial
0x63	DXE, CPU initial
0x68	DXE, North bridge Host Bridge initial
0x69	DXE, North bridge initial
0x6A	DXE, North bridge SMM initial
0x70	DXE, South bridge initial
0x71	DXE, South bridge SMM initial
0x72	DXE, South bridge devices initial
0x78	DXE, ACPI initial
0x79	DXE, CSM initial
0x90	DXE, BDS phase start
0x91	DXE, BDS connect drivers
0x92	DXE, PCI initial start
0x93 – 0x94	DXE, PCI initial
0x95	DXE, PCI check resource
0x96	DXE, PCI assign resource
0x97	DXE, Connect Console Out devices. (ex. VGA)
0x98	DXE, Connect Console In devices. (ex. Keyboard/Mouse)
0x99	DXE, Super IO initial
0x9A – 0x9D	DXE, USB initial
0xA0 – 0xA3	DXE, SATA initial
0xA4 – 0xA7	DXE, SCSI initial
0xA8	DXE, BIOS Setup verifying password
0xA9	DXE, BIOS Setup start
0xAB	DXE, BIOS Setup wait for input
0xAD	DXE, EFI ready to boot
0xAE	DXE, Legacy boot
0xAF	DXE, Exit boot services
0xB0	DXE, Set address map start
0xB1	DXE, Set address map end
0xB2	DXE, Legacy option ROM initial
0xB3	DXE, Reset system

(continued on the next page)

POST CODE	DESCRIPTION
0xB4	DXE, USB hot plug
0xB5	DXE, PCI hot plug
0xB6	DXE, NVRAM cleanup
0xB7	DXE, Configuration reset
0x50	PEI, Invalid memory type
0x50	PEI, Invalid memory speed
0x51	PEI, Check memory SPD fail
0x52	PEI, Invalid memory size
0x52	PEI, Memory mismatch
0x53	PEI, Memory not detected
0x53	PEI, Memory none useful
0x54	PEI, Memory error
0x55	PEI, Memory not installed
0x56	PEI, Invalid CPU type
0x56	PEI, Invalid CPU speed
0x57	PEI, CPU mismatch
0x58	PEI, CPU self-test failed
0x58	PEI, CPU cache error
0x59	PEI, CPU microcode update failed
0x59	PEI, CPU no microcode
0x5A	PEI, CPU internal error
0x5A	PEI, CPU error
0x5B	PEI, Reset not available
0xD0	DXE, CPU error
0xD1	DXE, North bridge error
0xD2	DXE, South bridge error
0xD3	DXE, ARCH protocol not available
0xD4	DXE, PCI out of resource
0xD5	DXE, Legacy option ROM no space
0xD6	DXE, No console out device
0xD7	DXE, No console in device
0xD8	DXE, Invalid password
0xD9	DXE, Boot option load error
0xDA	DXE, Boot option failed
0xDB	DXE, Flash update failed
0xDC	DXE, Reset not available

Notices

Federal Communications Commission Statement

This device complies with Part 15 of the FCC Rules. Operation is subject to the following two conditions:

- This device may not cause harmful interference.
- This device must accept any interference received including interference that may cause undesired operation.

This equipment has been tested and found to comply with the limits for a Class A digital device, pursuant to part 15 of the FCC Rules. These limits are designed to provide reasonable protection against harmful interference when the equipment is operated in a commercial environment. This equipment generates, uses, and can radiate radio frequency energy and, if not installed and used in accordance with the instruction manual, may cause harmful interference to radio communications. Operation of this equipment in a residential area is likely to cause harmful interference in which case the user will be required to correct the interference at his own expense.



The use of shielded cables for connection of the monitor to the graphics card is required to assure compliance with FCC regulations. Changes or modifications to this unit not expressly approved by the party responsible for compliance could void the user's authority to operate this equipment.

Compliance Statement of Innovation, Science and Economic Development Canada (ISED)

This device complies with Innovation, Science and Economic Development Canada licence exempt RSS standard(s). Operation is subject to the following two conditions: (1) this device may not cause interference, and (2) this device must accept any interference, including interference that may cause undesired operation of the device.

CAN ICES-003(A)/NMB-003(A)

Déclaration de conformité de Innovation, Sciences et Développement économique Canada (ISED)

Le présent appareil est conforme aux CNR d'Innovation, Sciences et Développement économique Canada applicables aux appareils radio exempts de licence. L'exploitation est autorisée aux deux conditions suivantes : (1) l'appareil ne doit pas produire de brouillage, et (2) l'utilisateur de l'appareil doit accepter tout brouillage radioélectrique subi, même si le brouillage est susceptible d'en compromettre le fonctionnement.

CAN ICES-003(A)/NMB-003(A)

Australia statement notice

From 1 January 2012 updated warranties apply to all ASUS products, consistent with the Australian Consumer Law. For the latest product warranty details please visit <https://www.asus.com/support/>. Our goods come with guarantees that cannot be excluded under the Australian Consumer Law. You are entitled to a replacement or refund for a major failure and compensation for any other reasonably foreseeable loss or damage. You are also entitled to have the goods repaired or replaced if the goods fail to be of acceptable quality and the failure does not amount to a major failure.

If you require assistance please call ASUS Customer Service 1300 2787 88 or visit us at <https://www.asus.com/support/>.



DO NOT throw the motherboard in municipal waste. This product has been designed to enable proper reuse of parts and recycling. This symbol of the crossed out wheeled bin indicates that the product (electrical and electronic equipment) should not be placed in municipal waste. Check local regulations for disposal of electronic products.



DO NOT throw the mercury-containing button cell battery in municipal waste. This symbol of the crossed out wheeled bin indicates that the battery should not be placed in municipal waste.

Declaration of compliance for product environmental regulation

ASUS follows the green design concept to design and manufacture our products, and makes sure that each stage of the product life cycle of ASUS product is in line with global environmental regulations. In addition, ASUS disclose the relevant information based on regulation requirements.

Please refer to <https://esg.asus.com/Compliance.htm> for information disclosure based on regulation requirements ASUS is complied with:

EU REACH and Article 33

Complying with the REACH (Registration, Evaluation, Authorization, and Restriction of Chemicals) regulatory framework, we publish the chemical substances in our products at ASUS REACH website at <https://esg.asus.com/Compliance.htm>.

EU RoHS

This product complies with the EU RoHS Directive. For more details, see <https://esg.asus.com/Compliance.htm>

Japan JIS-C-0950 Material Declarations

Information on Japan RoHS (JIS-C-0950) chemical disclosures is available on <https://esg.asus.com/Compliance.htm>

India RoHS

This product complies with the “India E-Waste (Management) Rules, 2016” and prohibits use of lead, mercury, hexavalent chromium, polybrominated biphenyls (PBBs) and polybrominated diphenyl ethers (PBDEs) in concentrations exceeding 0.1% by weight in homogenous materials and 0.01% by weight in homogenous materials for cadmium, except for the exemptions listed in Schedule II of the Rule.

Vietnam RoHS

ASUS products sold in Vietnam, on or after September 23, 2011, meet the requirements of the Vietnam Circular 30/2011/TT-BCT.

Các sản phẩm ASUS bán tại Việt Nam, vào ngày 23 tháng 9 năm 2011 trở về sau, đều phải đáp ứng các yêu cầu của Thông tư 30/2011/TT-BCT của Việt Nam.

Türkiye RoHS

AEEE Yönetmeliğine Uygundur

ASUS Recycling/Takeback Services

ASUS recycling and takeback programs come from our commitment to the highest standards for protecting our environment. We believe in providing solutions for you to be able to responsibly recycle our products, batteries, other components as well as the packaging materials. Please go to <https://esg.asus.com/en/Takeback.htm> for detailed recycling information in different regions.

Ecodesign Directive

The European Union announced a framework for the setting of ecodesign requirements for energy-related products (2009/125/EC). Specific implementing measures are aimed at improving environmental performance of specific products or across multiple product types. ASUS provides product information at <https://esg.asus.com/Compliance.htm>.

インターネット回線への接続に関するご注意

本製品は電気通信事業者（移动通信会社、固定通信会社、インターネットプロバイダ等）の通信回線（公衆無線LANを含む）に直接接続することができません。本製品をインターネットに接続する場合は、必ずルーター等を経由し接続してください。

Japan statement notice

This product cannot be directly connected to the Internet (including public wireless LAN) of a telecom carrier (mobile network companies, landline network companies, Internet providers, etc.). When connecting this product to the Internet, be sure to connect it through a router or switch.

Safety Precautions

Accessories that came with this product have been designed and verified for the use in connection with this product. Never use accessories for other products to prevent the risk of electric shock or fire.

安全上のご注意

付属品は当該専用品です。他の機器には使用しないでください。機器の破損もしくは、火災や感電の原因となることがあります。

Access Advance Patent Notice



Simplified EU Declaration of Conformity

English ASUSTeK Computer Inc. hereby declares that this device is in compliance with the essential requirements and other relevant provisions of related Directives. Full text of EU declaration of conformity is available at: www.asus.com/support

Français AsusTek Computer Inc. déclare par la présente que cet appareil est conforme aux critères essentiels et autres clauses pertinentes des directives concernées. La déclaration de conformité de l'UE peut être téléchargée à partir du site Internet suivant : www.asus.com/support

Deutsch ASUSTeK Computer Inc. erklärt hiermit, dass dieses Gerät mit den wesentlichen Anforderungen und anderen relevanten Bestimmungen der zugehörigen Richtlinien übereinstimmt. Der gesamte Text der EU-Konformitätserklärung ist verfügbar unter: www.asus.com/support

Italiano ASUSTeK Computer Inc. con la presente dichiara che questo dispositivo è conforme ai requisiti essenziali e alle altre disposizioni pertinenti con le direttive correlate. Il testo completo della dichiarazione di conformità UE è disponibile all'indirizzo: www.asus.com/support

Русский Компания ASUS заявляет, что это устройство соответствует основным требованиям и другим соответствующим условиям соответствующих директив. Подробную информацию, пожалуйста, смотрите на www.asus.com/support

Български С настоящото ASUSTeK Computer Inc. декларира, че това устройство е в съответствие със съществените изисквания и другите приложими постановления на свързаните директиви. Пълният текст на декларацията за съответствие на ЕС е достъпна на адрес: www.asus.com/support

Hrvatski ASUSTeK Computer Inc. ovim izjavljuje da je ovaj uređaj sukladan s bitnim zahtjevima i ostalim odgovarajućim odredbama vezanih direktiva. Cijeli tekst EU izjave o sukladnosti dostupan je na: www.asus.com/support

Čeština Společnost ASUSTeK Computer Inc. tímto prohlašuje, že toto zařízení splňuje základní požadavky a další příslušná ustanovení souvisejících směrnic. Plné znění prohlášení o shodě EU je k dispozici na adrese: www.asus.com/support

Dansk ASUSTeK Computer Inc. erklærer hermed, at denne enhed er i overensstemmelse med hovedkravene og andre relevante bestemmelser i de relaterede direktiver. Hele EU-overensstemmelseserklæringen kan findes på: www.asus.com/support

Nederlands ASUSTeK Computer Inc. verklaart hierbij dat dit apparaat voldoet aan de essentiële vereisten en andere relevante bepalingen van de verwante richtlijnen. De volledige tekst van de EU-verklaring van conformiteit is beschikbaar op: www.asus.com/support

Eesti Käesolevaga kinnitab ASUSTeK Computer Inc, et see seade vastab asjakohaste direktiivide oluliste nõuetele ja teistele asjassepuutuvatele sätetele. EL vastavusdeklaratsiooni täielik tekst on saadaval järgmisel aadressil: www.asus.com/support

Suomi ASUSTeK Computer Inc. ilmoittaa täten, että tämä laite on asiaankuuluvien direktiivien olennaisten vaatimusten ja muiden tätä koskevien säädösten mukainen. EU-yhdenmukaisuusilmoituksen koko teksti on luettavissa osoitteessa: www.asus.com/support

Ελληνικά Με το παρόν, η AsusTek Computer Inc. δηλώνει ότι αυτή η συσκευή συμμορφώνεται με τις θεμελιώδεις απαιτήσεις και άλλες σχετικές διατάξεις των Οδηγιών της ΕΕ. Το πλήρες κείμενο της δήλωσης συμβατότητας είναι διαθέσιμο στη διεύθυνση: www.asus.com/support

Magyar Az ASUSTeK Computer Inc. ezennel kijelenti, hogy ez az eszköz megfelel a kapcsolódó irányelvek lényeges követelményeinek és egyéb vonatkozó rendelkezéseinek. Az EU megfeleléségi nyilatkozat teljes szövege innen letölthető: www.asus.com/support

Latviski ASUSTeK Computer Inc. ar šo paziņo, ka šī ierīce atbilst saistīto Direktīvu būtiskajām prasībām un citiem citiem saistošajiem nosacījumiem. Pilns ES atbilstības paziņojuma teksts pieejams šeit: www.asus.com/support

Lietuvių „ASUSTeK Computer Inc.“ šiuo tvirtina, kad šis įrenginys atitinka pagrindinius reikalavimus ir kitas svarbias susijusių direktyvų nuostatas. Visą ES atitikties deklaracijos tekstą galima rasti: www.asus.com/support

Norsk ASUSTeK Computer Inc. erklærer herved at denne enheten er i samsvar med hovedsaklige krav og andre relevante forskrifter i relaterte direktiver. Fullstendig tekst for EU-samsvarserklæringen finnes på: www.asus.com/support

Polski Firma ASUSTeK Computer Inc. niniejszym oświadcza, że urządzenie to jest zgodne z zasadniczymi wymogami i innymi właściwymi postanowieniami powiązanych dyrektyw. Pełny tekst deklaracji zgodności UE jest dostępny pod adresem: www.asus.com/support

Português A ASUSTeK Computer Inc. declara que este dispositivo está em conformidade com os requisitos essenciais e outras disposições relevantes das Diretivas relacionadas. Texto integral da declaração da UE disponível em: www.asus.com/support

Română ASUSTeK Computer Inc. declară că acest dispozitiv se conformează cerințelor esențiale și altor prevederi relevante ale directivelor conexe. Textul complet al declarației de conformitate a Uniunii Europene se găsește la: www.asus.com/support

Srpski ASUSTeK Computer Inc. ovim izjavljuje da je ovaj uređaj u saglasnosti sa osnovnim zahtevima i drugim relevantnim odredbama povezanih Direktiva. Pun tekst EU deklaracije o usaglašenosti je dostupan da adresi: www.asus.com/support

Slovensky Spoločnosť ASUSTeK Computer Inc. týmto vyhlasuje, že toto zariadenie vyhovuje základným požiadavkám a ostatým príslušným ustanoveniam príslušných smerníc. Celý text vyhlásenia o zhode pre štáty EÚ je dostupný na adrese: www.asus.com/support

Slovenščina ASUSTeK Computer Inc. izjavlja, da je ta naprava skladna z bistvenimi zahtevami in drugimi ustreznimi določbami povezanih direktiv. Celotno besedilo EU-izjave o skladnosti je na voljo na spletnem mestu: www.asus.com/support

Español Por la presente, ASUSTeK Computer Inc. declara que este dispositivo cumple los requisitos básicos y otras disposiciones pertinentes de las directivas relacionadas. El texto completo de la declaración de la UE de conformidad está disponible en: www.asus.com/support

Svenska ASUSTeK Computer Inc. förklarar härmed att denna enhet överensstämmer med de grundläggande kraven och andra relevanta föreskrifter i relaterade direktiv. Fulltext av EU-försäkran om överensstämmelse finns på: www.asus.com/support

Українська ASUSTeK Computer Inc. заявляє, що цей пристрій відповідає основним вимогам та іншим відповідним положенням відповідних Директив. Повний текст декларації відповідності стандартам ЄС доступний на: www.asus.com/support

Türkçe AsusTek Computer Inc., bu aygıtın temel gereksinimlerle ve ilişkili Yönergelerin diğer ilgili koşullarıyla uyumlu olduğunu beyan eder. AB uygunluk bildiriminin tam metni şu adreste bulunabilir: www.asus.com/support

Bosanski ASUSTeK Computer Inc. ovim izjavljuje da je ovaj uređaj usklađen sa bitnim zahtjevima i ostalim odgovarajućim odredbama vezanih direktiva. Cijeli tekst EU izjave o usklađenosti dostupan je na: www.asus.com/support

Simplified UKCA Declaration of Conformity

ASUSTeK Computer Inc. hereby declares that this device is in compliance with the essential requirements and other relevant provisions of related Regulations. Full text of UKCA declaration of conformity is available at: www.asus.com/support

FCC COMPLIANCE INFORMATION

Per FCC Part 2 Section 2.1077



Responsible Party: Asus Computer International
Address: 48720 Kato Rd., Fremont, CA 94538
Phone/Fax No: (510)739-3777/(510)608-4555

hereby declares that the product

Product Name : Server
Model Number : RS300-E12-PS4 · RS300-E12-RS4

compliance statement:

This device complies with part 15 of the FCC Rules. Operation is subject to the following two conditions: (1) This device may not cause harmful interference, and (2) this device must accept any interference received, including interference that may cause undesired operation.

Ver. 180125

Service and Support

Visit our multi-language website at <https://www.asus.com/support>.



