









F36



















































MATX GAMING CASE

USER MANUAL
BENUTZERHANDBUCH
MANUAL DO USUÁRIO
РУКОВОДСТВО ПОЛЬЗОВАТЕЛЯ
用户手册

Package Content - Paket Inhalt - Conteúdo do pacote - Содержание пакета - 包装内容

	Image	Q'ty	Used for / Benutzt für / Usado para / Используется для / 用途
A		10	MB Screw / MB-Schraube / Parafuso MB / МБ Винт / 主板螺丝
B		6	PSU Screw / Stromversorgungsschraube / Parafuso de fonte de alimentação / Винт питания / 电源螺丝
C		6	3.5" HDD Screws / 3,5" HDD-Schrauben / Parafusos do HDD de 3,5 pol. / Винты для жесткого диска 3,5" твердотельного накопителя / 3.5" HDD硬盘螺丝
D		8	2.5" SSD Screws / 2,5" SSD-Schrauben / Parafusos de SSD de 2,5 pol. / Винты для 2,5" твердотельных накопителей / 2.5" SSD硬盘螺丝
E		4	Hard Drive Damper / Festplattendämpfer / Amortecedor de disco rígido / Демпфер жесткого диска / 硬盘减震垫
F		1	Hex Wrench / Sechskantschlüssel / Chave sextavada / Шестигранный ключ / 铁柱套筒
G		2	Motherboard Standoff / MB-Abstand / MB sobressalente / МБ Противостояние / 主板铁柱
H		6	Cable Tie / Kabelbinder / Abraçadeira / Кабельная стяжка / 束线带

Connectors - Anschlüsse - Conectores - Разъёмы - 连接器

<p> PORT 1L  AUG GND PORT 1R  PRESENCE PORT 2R  SENSE1_R SENCE_S  SENSE1_R PORT 2L  SENSE2_R </p> 	<p>Combo Audio</p>	 <p>POWER SW</p>	<p>POWER SW</p>
<p> VBUS  S5RX1+ S5RX1+  GND S5TX1+  GND D1+  NC VBUS  S5RX2+ S5RX2+  GND S5TX2+  GND D2+  D2+ </p> 	<p>USB3.0</p>		
<p> A1 D001  GND B12 A2 D002  B01 B11 A3 D003  B02 B03 A4 D004  B04 B05 A5 D005  B06 B07 A6 D006  B08 B09 A7 D007  B10 B11 A8 D008  B12 B13 A9 D009  B14 B15 A10 D010  B16 B17 A11 D011  B18 B19 A12 D012  B20 B21 A13 D013  B22 B23 A14 D014  B24 B25 A15 D015  B26 B27 A16 D016  B28 B29 A17 D017  B30 B31 A18 D018  B32 B33 A19 D019  B34 B35 A20 D020  B36 B37 A21 D021  B38 B39 A22 D022  B40 B41 A23 D023  B42 B43 A24 D024  B44 B45 A25 D025  B46 B47 A26 D026  B48 B49 A27 D027  B50 B51 A28 D028  B52 B53 A29 D029  B54 B55 A30 D030  B56 B57 A31 D031  B58 B59 A32 D032  B60 B61 A33 D033  B62 B63 A34 D034  B64 B65 A35 D035  B66 B67 A36 D036 B68 B69 A37 D037 B70 B71 A38 D038 B72 B73 A39 D039 B74 B75 A40 D040 B76 B77 A41 D041 B78 B79 A42 D042 B80 B81 A43 D043 B82 B83 A44 D044 B84 B85 A45 D045 B86 B87 A46 D046 B88 B89 A47 D047 B90 B91 A48 D048 B92 B93 A49 D049 B94 B95 A50 D050 B96 B97 A51 D051 B98 B99 A52 D052 B100 B101 A53 D053 B102 B103 A54 D054 B104 B105 A55 D055 B106 B107 A56 D056 B108 B109 A57 D057 B110 B111 A58 D058 B112 B113 A59 D059 B114 B115 A60 D060 B116 B117 A61 D061 B118 B119 A62 D062 B120 B121 A63 D063 B122 B123 A64 D064 B124 B125 A65 D065 B126 B127 A66 D066 B128 B129 A67 D067 B130 B131 A68 D068 B132 B133 A69 D069 B134 B135 A70 D070 B136 B137 A71 D071 B138 B139 A72 D072 B140 B141 A73 D073 B142 B143 A74 D074 B144 B145 A75 D075 B146 B147 A76 D076 B148 B149 A77 D077 B150 B151 A78 D078 B152 B153 A79 D079 B154 B155 A80 D080 B156 B157 A81 D081 B158 B159 A82 D082 B160 B161 A83 D083 B162 B163 A84 D084 B164 B165 A85 D085 B166 B167 A86 D086 B168 B169 A87 D087 B170 B171 A88 D088 B172 B173 A89 D089 B174 B175 A90 D090 B176 B177 A91 D091 B178 B179 A92 D092 B180 B181 A93 D093 B182 B183 A94 D094 B184 B185 A95 D095 B186 B187 A96 D096 B188 B189 A97 D097 B190 B191 A98 D098 B192 B193 A99 D099 B194 B195 A100 D100 B196 B197 A101 D101 B198 B199 A102 D102 B200 B201 A103 D103 B202 B203 A104 D104 B204 B205 A105 D105 B206 B207 A106 D106 B208 B209 A107 D107 B210 B211 A108 D108 B212 B213 A109 D109 B214 B215 A110 D110 B216 B217 A111 D111 B218 B219 A112 D112 B220 B221 A113 D113 B222 B223 A114 D114 B224 B225 A115 D115 B226 B227 A116 D116 B228 B229 A117 D117 B230 B231 A118 D118 B232 B233 A119 D119 B234 B235 A120 D120 B236 B237 A121 D121 B238 B239 A122 D122 B240 B241 A123 D123 B242 B243 A124 D124 B244 B245 A125 D125 B246 B247 A126 D126 B248 B249 A127 D127 B250 B251 A128 D128 B252 B253 A129 D129 B254 B255 A130 D130 B256 B257 A131 D131 B258 B259 A132 D132 B260 B261 A133 D133 B262 B263 A134 D134 B264 B265 A135 D135 B266 B267 A136 D136 B268 B269 A137 D137 B270 B271 A138 D138 B272 B273 A139 D139 B274 B275 A140 D140 B276 B277 A141 D141 B278 B279 A142 D142 B280 B281 A143 D143 B282 B283 A144 D144 B284 B285 A145 D145 B286 B287 A146 D146 B288 B289 A147 D147 B290 B291 A148 D148 B292 B293 A149 D149 B294 B295 A150 D150 B296 B297 A151 D151 B298 B299 A152 D152 B300 B301 A153 D153 B302 B303 A154 D154 B304 B305 A155 D155 B306 B307 A156 D156 B308 B309 A157 D157 B310 B311 A158 D158 B312 B313 A159 D159 B314 B315 A160 D160 B316 B317 A161 D161 B318 B319 A162 D162 B320 B321 A163 D163 B322 B323 A164 D164 B324 B325 A165 D165 B326 B327 A166 D166 B328 B329 A167 D167 B330 B331 A168 D168 B332 B333 A169 D169 B334 B335 A170 D170 B336 B337 A171 D171 B338 B339 A172 D172 B340 B341 A173 D173 B342 B343 A174 D174 B344 B345 A175 D175 B346 B347 A176 D176 B348 B349 A177 D177 B350 B351 A178 D178 B352 B353 A179 D179 B354 B355 A180 D180 B356 B357 A181 D181 B358 B359 A182 D182 B360 B361 A183 D183 B362 B363 A184 D184 B364 B365 A185 D185 B366 B367 A186 D186 B368 B369 A187 D187 B370 B371 A188 D188 B372 B373 A189 D189 B374 B375 A190 D190 B376 B377 A191 D191 B378 B379 A192 D192 B380 B381 A193 D193 B382 B383 A194 D194 B384 B385 A195 D195 B386 B387 A196 D196 B388 B389 A197 D197 B390 B391 A198 D198 B392 B393 A199 D199 B394 B395 A200 D200 B396 B397 A201 D201 B398 B399 A202 D202 B400 B401 A203 D203 B402 B403 A204 D204 B404 B405 A205 D205 B406 B407 A206 D206 B408 B409 A207 D207 B410 B411 A208 D208 B412 B413 A209 D209 B414 B415 A210 D210 B416 B417 A211 D211 B418 B419 A212 D212 B420 B421 A213 D213 B422 B423 A214 D214 B424 B425 A215 D215 B426 B427 A216 D216 B428 B429 A217 D217 B430 B431 A218 D218 B432 B433 A219 D219 B434 B435 A220 D220 B436 B437 A221 D221 B438 B439 A222 D222 B440 B441 A223 D223 B442 B443 A224 D224 B444 B445 A225 D225 B446 B447 A226 D226 B448 B449 A227 D227 B450 B451 A228 D228 B452 B453 A229 D229 B454 B455 A230 D230 B456 B457 A231 D231 B458 B459 A232 D232 B460 B461 A233 D233 B462 B463 A234 D234 B464 B465 A235 D235 B466 B467 A236 D236 B468 B469 A237 D237 B470 B471 A238 D238 B472 B473 A239 D239 B474 B475 A240 D240 </p>			

Exploded View - Explosionszeichnung - Vista expandida - В разобранном виде - 爆炸分解图

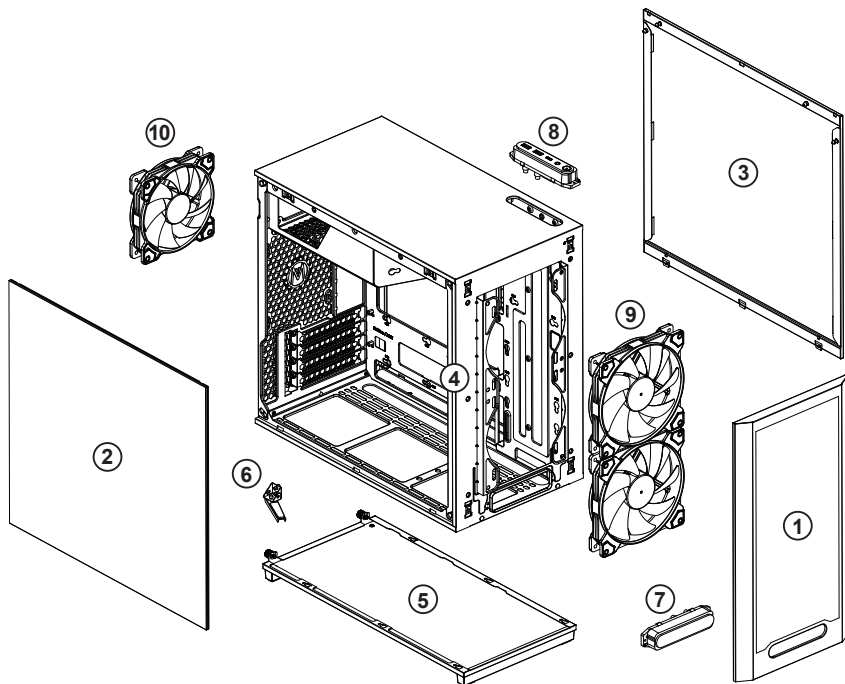

<p>①</p>	<p>Front Panel / Frontblende / Painel frontal / Передняя панель / 面板</p>	<p>⑥</p>	<p>GPU Card Holder / GPU -Kartenhalter / Titular do cartão GPU / Владелец карты графического процессора / 显卡支架</p>
<p>②</p>	<p>Left side panel / Linke Seitenplatte / Painel lateral esquerdo / Левая панель / 左侧板</p>	<p>⑦</p>	<p>LOGO Component / Logo -Komponente / Componente do logotipo / Логотип компонент / LOGO组件</p>
<p>③</p>	<p>Right side panel / Rechte Seite / Painel lateral direito / Правая панель / 右侧板</p>	<p>⑧</p>	<p>IO Component / Yo Komponente / Seu componente / Yo компонент / IO组件</p>
<p>④</p>	<p>Chassis / Chassis / Chassis / Шасси / 机架</p>	<p>⑨</p>	<p>Front 140mm fan x2(included) / Vordere 140 -mm -Lüfter x2 (enthalten) / Fan de 140 mm dia x2 (incluído) / Передний 140 -мм вентилятор x2 (включен) / 前板140mm风扇 x2(标配)</p>
<p>⑤</p>	<p>Detachable bottom plate / Abnehmbare untere Platte / Placa inferior destacável / Съемная нижняя пластина / 可拆卸式底板</p>	<p>⑩</p>	<p>Rear 120mm fan x1(included) / Heck 120mm Lüfter x1 (enthalten) / Fan de 120 mm traseiro x1 (incluído) / Задний 120 -мм вентилятор x1 (включен) / 后板120mm风扇 x1(标配)</p>

Installation Guide - Installationsanleitung - Guia de instalação - Инструкция по установке - 安装指南

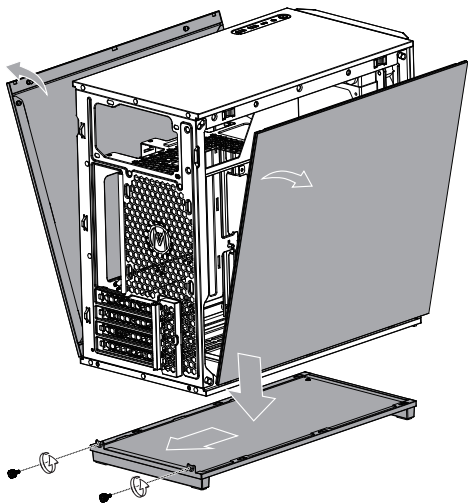

Remove the left and right side panel and bottom plate

Entfernen Sie die linke und die rechte Seitenplatte und die untere Platte

Remova a placa lateral esquerda e direita e a placa inferior

Снимите левую и правую боковую доску и нижнюю пластину

取下左右侧板和底板。

Installation Guide - Installationsanleitung - Guia de instalação - Инструкция по установке - 安装指南

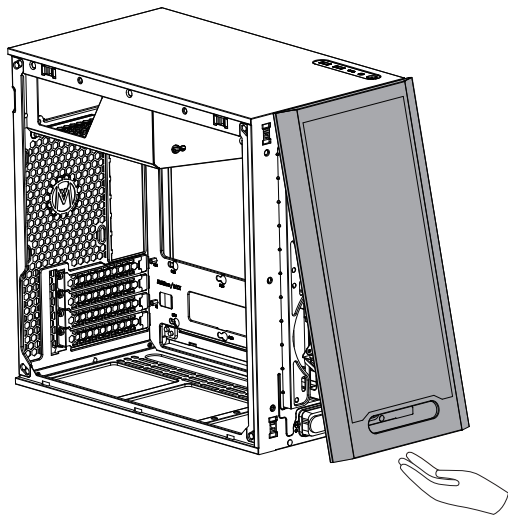

Remove the front panel

Entfernen Sie die Frontplatte

Remova o painel frontal

Снимите переднюю панель

取下前板

Installation Guide - Installationsanleitung - Guia de instalação - Инструкция по установке - 安装指南

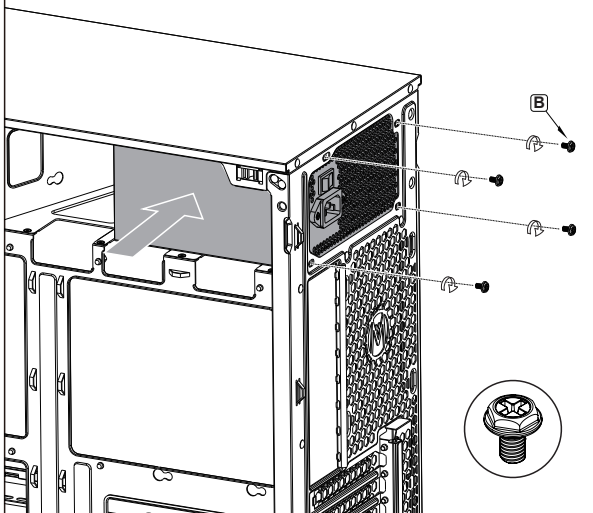

Insert PSU from right side, secure with screws.

Setzen Sie PSU von der rechten Seite ein und sicher mit Schrauben.

Insira a PSU do lado direito, prenda com parafusos.

Вставьте PSU с правой стороны, закрепите винтами.

将电源从右侧置入，对齐孔位，锁上电源螺丝。

Installation Guide - Installationsanleitung - Guia de instalação - Инструкция по установке - 安装指南

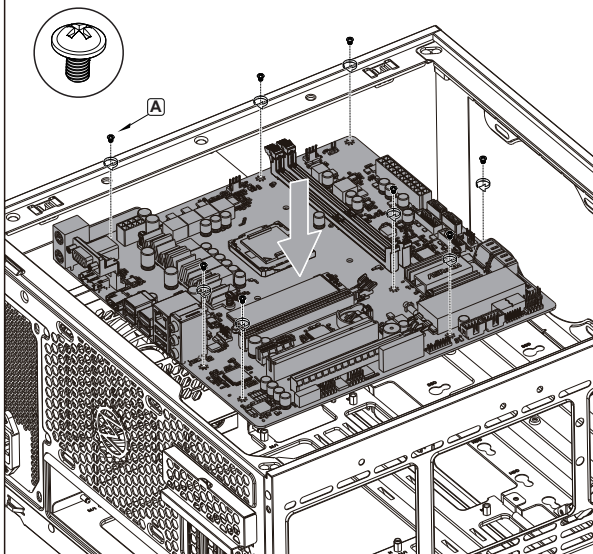

Put in the motherboard, place the I/O baffle, and lock the screws.

Setzen Sie die Hauptplatine ein, bringen Sie die E/A-Abdeckung an und ziehen Sie die Schrauben fest.

Coloque a placa-mãe, posicione o defletor de E/S e trave os parafusos.

Установите материнскую плату, установите перегородку ввода-вывода и закрепите винты.

安装主板。

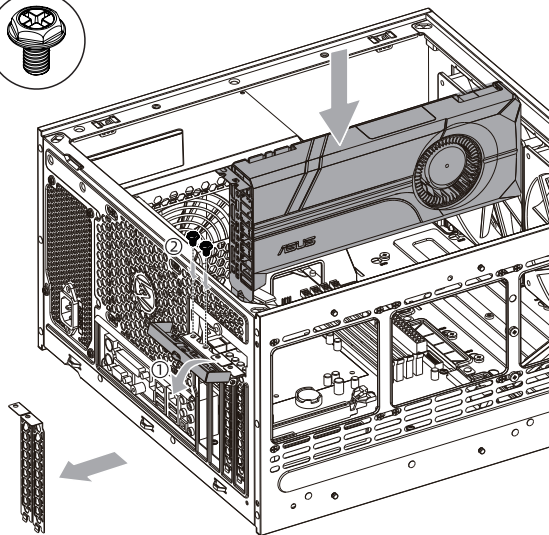

- ① Open the magnetic PCI-E baffle
- ② Remove the PCI-E interface card, put it in the graphics card, lock the screw fixation

- ① Öffnen Sie die magnetische PCI-E-Schale
- ② Entfernen Sie die PCI-E-Schnittstellenkarte, legen Sie sie in die Grafikkarte, sperren Sie die Schraubfixierung

- ① Abra o defletor magnético PCI-E
- ② Remova a placa de interface PCI-E, coloque-a na placa de gráfico, bloqueie a fixação do parafuso

- ① Откройте магнитную перегородку PCI-E
- ② Снимите интерфейсную карту PCI-E, поместите ее на видеокарту, заблокируйте фиксацию винта

- ① 打开磁吸式PCI-E挡板
- ② 取下PCI-E界面卡条，放入显卡，锁上螺丝固定

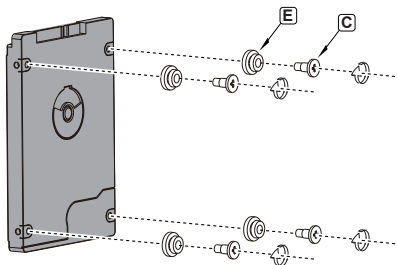

Install SSD and HDD lock-free screws

Installieren Sie SSD- und HDD-Sperrschrauben

Instale os parafusos sem trava SSD e HDD

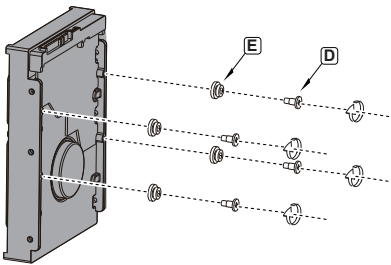

Установить винты SSD и HDD-блокировки

安装SSD和HDD免锁螺丝

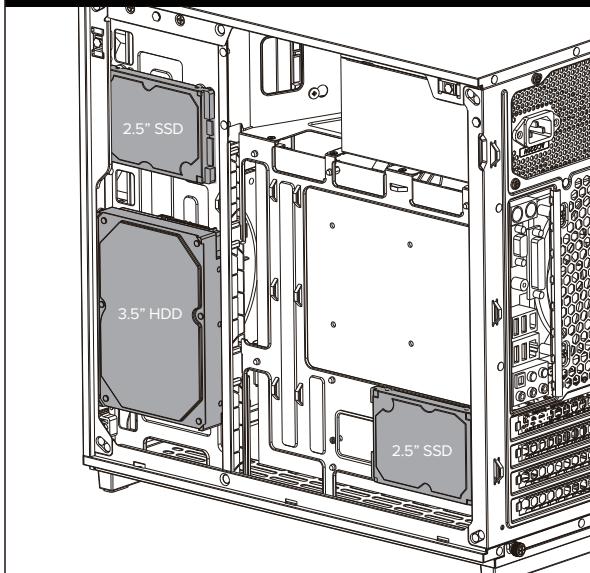

Install 3.5" HDD and 2.5" SSD

Installieren Sie 3,5" HDD und 2,5" SSD

Instale o SSD de 3,5" HDD e 2,5"

Установить 3,5" HDD и 2,5" SSD

安装2.5" SSD和3.5" HDD硬盘

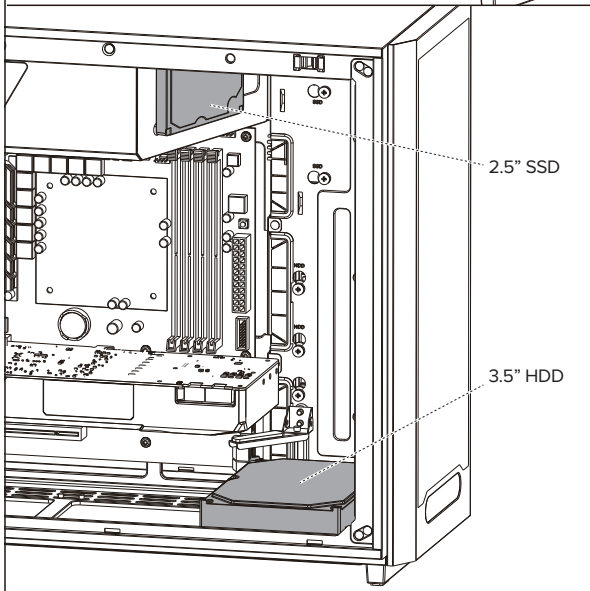

Install 3.5" HDD and 2.5" SSD

* If a 3.5-inch hard drive is installed at the bottom, only 2*120mm fans or 1*140mm fan can be installed.

Installieren Sie 3,5" HDD und 2,5" SSD

* Wenn unten eine 3,5-Zoll-Festplatte installiert ist, können nur 2*120-mm-Lüfter oder 1*140-mm-Lüfter installiert werden.

Instale o HDD de 2,5" SSD e 3,5"

*Se um disco rígido de 3,5 polegadas estiver instalado na parte inferior, apenas 2*120mm ou ventilador de 1*140mm poderão ser instalados.

Установить 3,5" HDD и 2,5" SSD

*Если внизу установлен 3,5-дюймовый жесткий диск, можно установить только 2*120 мм вентилятора или 1*140 мм вентилятора.

安装2.5" SSD和3.5" HDD硬盘

注意：当底板安装3.5" HDD后，只能安装两个120mm风扇或者一个140mm风扇。

Installation Guide - Installationsanleitung - Guia de instalação - Инструкция по установке - 安装指南

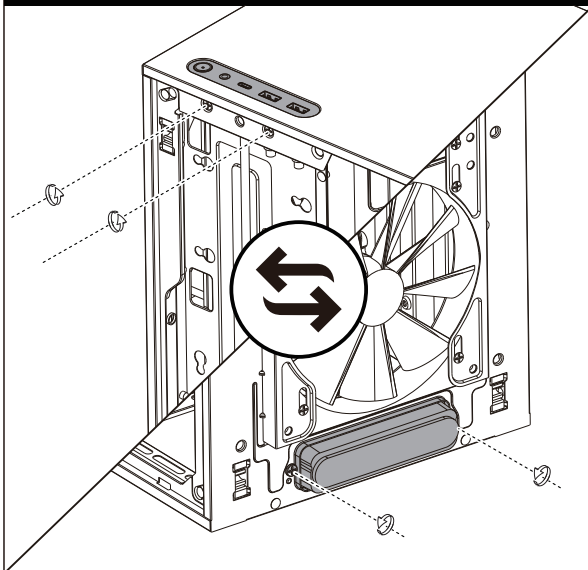

I/O Component can Exchange Position with LOGO Component

IO -Komponente kann die Position austauschen mit Logo -Komponente

O componente IO pode trocar a posição com componente de logotipo

Компонент IO может обмениваться позицией с компонентом логотипа

IO接口模块可与前板LOGO组件互换，实现前置IO

Cooling System - Installationsanleitung - Guia de instalação - Инструкция по установке - 散热支持

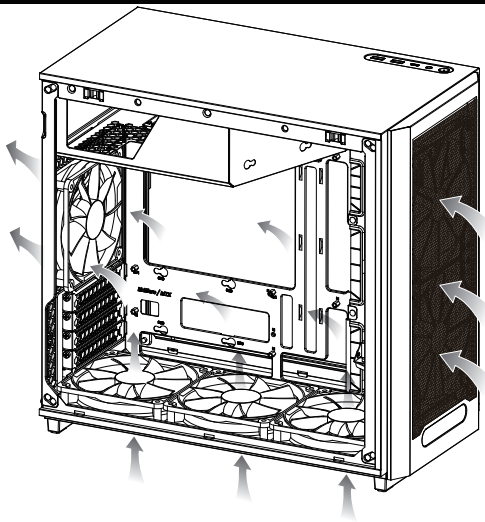

Fan Cooling System:

Front: 2x120mm(optional), 2x140mm(included)

Bottom: 3x120mm / 2x140mm(optional)

Rear: 1x120mm(included)

Liquid Cooling System:

Front: 120/240/280mm(optional)

Rear: 120mm(optional)